

**Lighthouse Collection - USA
Edition
Powder Coat**

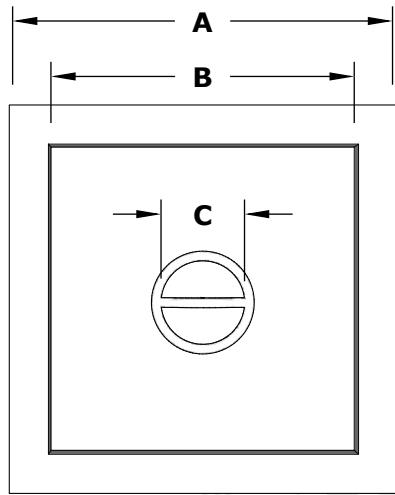

TOP VIEW

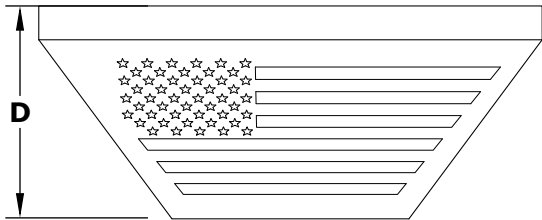

FRONT SIDE VIEW

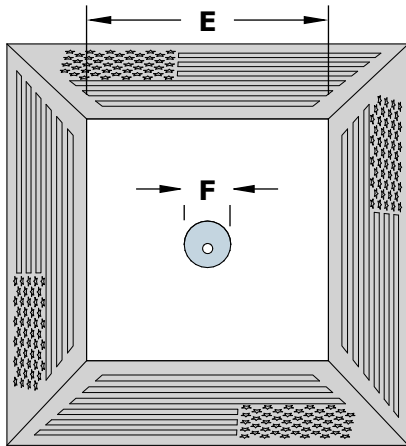

BOTTOM VIEW

SPECIFICATION

PART NUMBER	A	B	C	D	E	F
OPT-LHFOUSAPC24	24"	18"	8"	12"	12"	3"
OPT-LHFOUSAPC30	30"	24"	8"	12"	15"	3"
OPT-LHFOUSAPC36	36"	30"	12"	12"	18"	3"



Match Lit Unit Includes: Pan, Burner, Gas Orifice, Gas Hoses

12v Ignition Unit Includes: Pan, Burner, Gas Orifice, Gas Hoses, Low Voltage Electronic Valve, Pilot Igniter.

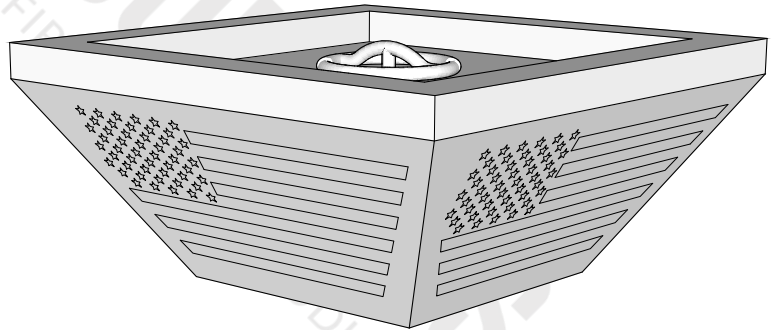

ISOMETRIC VIEW

Drawn By	Daniel M
Date Created	October 3, 2023

Lighthouse Collection - USA
Edition - 12V Electronic Ignition
 Powder Coat

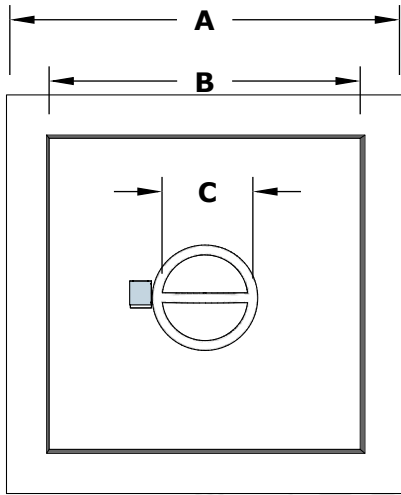

TOP VIEW

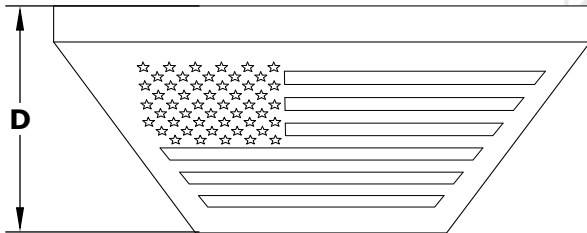

FRONT SIDE VIEW

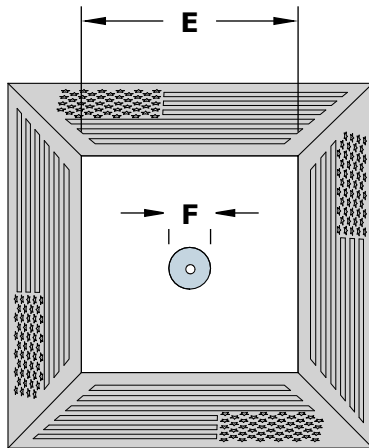

BOTTOM VIEW

SPECIFICATION

PART NUMBER	A	B	C	D	E	F
OPT-LHFOUSAPC24E12V	24"	18"	8"	12"	12"	3"
OPT-LHFOUSAPC30E12V	30"	24"	8"	12"	15"	3"
OPT-LHFOUSAPC36E12V	36"	30"	12"	12"	18"	3"

Match Lit Unit Includes: Pan, Burner, Gas Orifice, Gas Hoses

12v Ignition Unit Includes: Pan, Burner, Gas Orifice, Gas Hoses, Low Voltage Electronic Valve, Pilot Igniter.

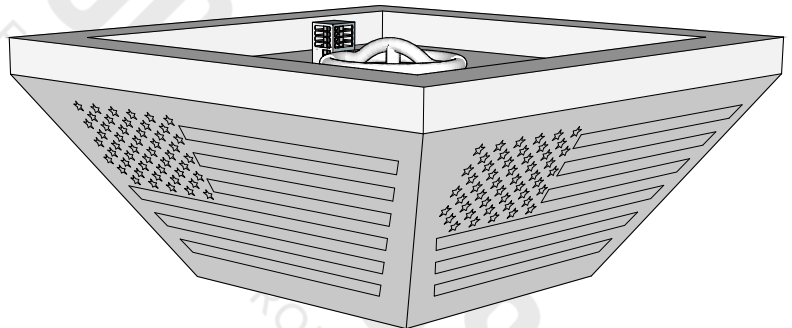

ISOMETRIC VIEW

Drawn By	Daniel M
Date Created	October 3, 2023

Proprietary & Confidential: The information contained in this drawing is the sole property of **The Outdoor Plus**. Any reproduction or as a whole without written permission of **The Outdoor Plus** is prohibited.