

SMART Burners

Installation & User Manual



User's Manual



Table of Contents	2
<hr/>	
Register your Warranty	4
<hr/>	
Important Safety Information	5
1. Explosion or Fire Hazard	5
2. Fueling The Burner	5
3. Operating The Burner	6
4. Burner Accessories	6
<hr/>	
The Bio Flame's Ethanol Fuel	7
<hr/>	
Included Accessories	8
<hr/>	
All Burner Dimensions	8
<hr/>	
Clearances & Installation	9
1. Clearances	9
2. Installation	10
3. Ideal Location	11
<hr/>	
Burner Efficiency & Ventilation	12
<hr/>	
Operating The Burner	13
1. Required Reading Before Use	13
2. Filling The Burner	13
a. Automatic Fill	14
b. Manual Fill	14
3. Flame Size Adjustment	15
4. Turning Your Burner OFF	15
5. Child Lock (Optional)	15
6. Fine Adjusting	16
a. Fine adjusting the first chamber	16
b. Fine adjusting the second chamber (only applicable for burners with two chambers)	17

Table of Contents

7. Level the combustion tray	18
8. Siphon Fuel Out of Burner	18

Care & Maintenance	19
--------------------	----

Troubleshooting	21
-----------------	----

Why Register Your Warranty?

Registering your warranty goes beyond just activating it; it allows our head office to communicate crucial safety and regulatory information to you when necessary.

This includes:

- Timely notification in the unlikely event of a potential hazard
- Updates on fuel storage regulations, supply channels, or exclusive offers
- Reminders about regular safety procedures and maintenance
- Announcements of new models or accessories that complement or enhance your purchase.

If you purchased your product through an external distributor, retailer, or agent, please note that we may not have these details on file. We encourage you to register your warranty today online at <https://thebioflame.com/pages/warranty>

Considerations:

- Failure to properly install the burner will void the warranty and render the product unapproved for use with the included burner.
- Installation costs will not be reimbursed as damages for any reason whatsoever.
- The Bio Flame will not be held responsible for any incidental or consequential defects on goods or individuals.
- The warranty will not apply if devices have been subjected to abnormal use or if they are used under conditions other than the intended ones.
- The warranty will not apply in case of deterioration or accident due to negligence or damage caused by failing to maintain and service the device or resulting from an alteration of material.

Explosion or Fire Hazard

- a. We recommend using The Bio Flame's Bioethanol Fuel for optimal function. Under no circumstances should gasoline be used.
- b. Store fuel only in the original container. Keep it away from the area where the appliance is located.
- c. Before refueling, make sure the fuel chamber is completely empty and cooled down.
- d. Immediately wipe up any spills with a dry cloth, followed by a cloth dampened with water. Allow the area to dry completely before relighting the Burner.
- e. Do not operate the appliance in a room where oxygen tanks are in use or if flammable vapors are present.
- f. This appliance is designed for decorative purposes only and is not suitable for continuous operation. Do not use the appliance to heat or boil water, or as a cooking appliance. Additionally, refrain from placing wood, charcoal, paper, or other combustible objects in the Fire.
- g. Do not attempt to move or relocate the appliance while it is in use.

Fueling The Burner

- a. The Bio Flame's Bioethanol Fuel and any other recommended fuel are flammable liquids; therefore, they should be stored in the original container, away from heat and sources of ignition.
- b. The Bio Flame is not liable for any damage caused by using any other type of fuel other than the recommended ones.

Operating The Burner

- a. Do not use the appliance if it is damaged or malfunctioning.
- b. Remove the Burner frequently to check for residual fuel underneath. Fuel accumulation underneath could cause an explosion.
- c. Never leave a fire unattended.
- d. The appliance must be fully assembled before operation. Failure to install will void the warranty and render the product unapproved for use with the included burner.

Burner Accessories

- a. Only use authorized accessories and tools with your appliance. Accessories and tools supplied by The Bio Flame are strongly recommended.
- b. To reduce the risk of fire or injury, do not modify the appliance in any way.
- c. Pebbles or other refractory decorative fire accessories should not be placed directly over the Burner's mouth or interfere with the flame.



Use of The Bio Flame's Bioethanol Fuel:

The Bio Flame's Bioethanol Fuel is the fuel recommended to use with all The Bio Flame burners. As an alternative, you can also use e-NRG with your burner.

Flammable:







It is imperative to familiarize yourself with and adhere to local regulations to safely store, handle, decant, and utilize The Bio Flame's Bioethanol Fuel.











Ethanol, the primary component of The Bio Flame's Bioethanol Fuel, poses a significant flammability risk if proper precautions to minimize the likelihood of ignition are not followed.

To order your The Bio Flame's Bioethanol Fuel, please go to our website www.thebioflame.com

Included Accessories

Product		Included Accessories					
							
COLLECTION	TYPE OF BURNER	USER MANUAL	AC ADAPTER & PLUG	FILLING HOSE	SIPHON HOSE	LIFT UP HANDLE	REMOTE CONTROL
Firebox Collection	Smart	1	1	1	1	1	1
SMART Collection	Smart	1	1	1	1	1	1

All Burners Dimensions

	BURNER NAME	DIMENSIONS (INCHES)	DIMENSIONS (MM)
	18" RC Burner	6.6"× 18"×7.6"	168×457×193
	24" RC Burner	6.6"× 24"×7.6"	168×610×193
	30" RC Burner	6.6"× 30"×7.6"	168×762×193
	38" RC Burner	6.6"× 36"×7.6"	168×908×193
	48" RC Burner	6.6"× 48"×7.6"	168×1220×193
	60" RC Burner	6.6"× 60"×7.6"	168×1524×193
	72" RC Burner	6.6"× 72"×7.6"	168×1828.8×193
	84" RC Burner	6.6"× 84"×7.6"	168×2133.6×193
	96" RC Burner	6.6"× 96"×7.6"	168×2438.4×193

Clearances

If you plan to install your Bio Flame burner in a firebox, please ensure to follow the following clearances:

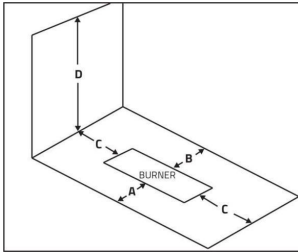

FRONT (A)	REAR (B)	SIDE (C)	OVERHEAD (D)	NEAREST COMBUSTIBLE RADIUS
4" [102 mm]	4" [102 mm]	4" [102 mm]	24" [610 mm]	24" [610 mm]

NOTE: The Bio Flame ethanol burners are designed to be ventless, requiring no chimneys or pipes due to their use of clean-burning bioethanol fuel.

When building custom-made fireboxes for Bio Flame burners, please ensure that:

- The firebox is made from non-combustible materials such as stone, cement sheet, and stainless steel.
- It is designed to accommodate a Top Tray.
- Leave a hole in one side of the firebox for the burner connector.

See below for a list of cut dimensions for each burner:

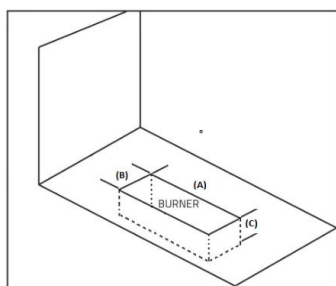

MODEL	LENGTH	WIDTH	DEPTH
18" RC Burner	17.52" [455 mm]	7.09" [180 mm]	9.84" [250 mm]
24" RC Burner	23.54" [598 mm]	7.09" [180 mm]	9.84" [250 mm]
30" RC Burner	29.53" [750 mm]	7.09" [180 mm]	9.84" [250 mm]
38" RC Burner	35.28" [896 mm]	7.09" [180 mm]	9.84" [250 mm]
48" RC Burner	47.56" [1208 mm]	7.09" [180 mm]	9.84" [250 mm]
60" RC Burner	59.53" [1512 mm]	7.09" [180 mm]	9.84" [250 mm]
72" RC Burner	71.54" [1817 mm]	7.09" [180 mm]	9.84" [250 mm]
84" RC Burner	83.50" [2121 mm]	7.09" [180 mm]	9.84" [250 mm]
96" RC Burner	95.51" [2426 mm]	7.09" [180 mm]	9.84" [250 mm]

IMPORTANT NOTE: The Bio Flame recommends using the Burner exclusively in a firebox manufactured by The Bio Flame. The Bio Flame is not liable for any injuries or damage sustained through the use of custom-made or privately commissioned fireboxes. The Bio Flame ethanol burners are designed to be ventless, requiring no chimneys or pipes due to their use of clean-burning bioethanol fuel.

Installation

There are various installation options available for the Burner. Regardless of the variation, the Burner must adhere to the following guidelines:

- It must be installed exclusively into non-combustible materials, such as stainless steel, concrete, brick, and natural stone.
- Remove all packaging materials prior to installing the burner.
- Choose a location at least four feet away from flammable objects or materials (drapes, fabrics, furniture, etc.).
- Installation should take place only after all gas connections or pipelines in the area are disconnected and secured by a qualified and licensed professional.
- Connect the power adapter from the right side of the burner. Prepare all electrical wiring before installation.
- The Burner should be securely fixed in position before filling, lighting, and operating. Moving the Burner poses a risk of accidental fuel spillage. If relocation is necessary, ensure no fuel spilled before ignition.
- Place the fireplace on a floor or sturdy surface, ensuring it is perfectly leveled using a spirit level.

Installation Steps

1. Plug in the AC adapter properly (and smart home wire if the unit is upgraded with a smart home system).

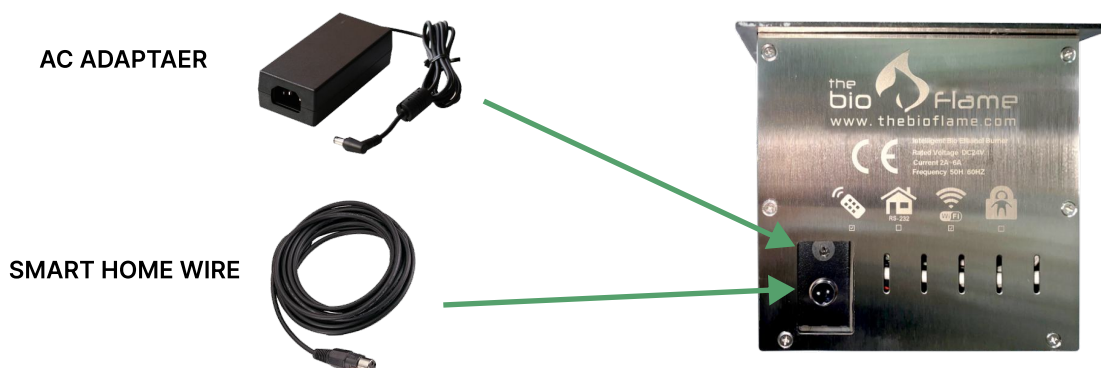

2. Lift the fireplace and slowly place it in a horizontal position, avoiding shaking.

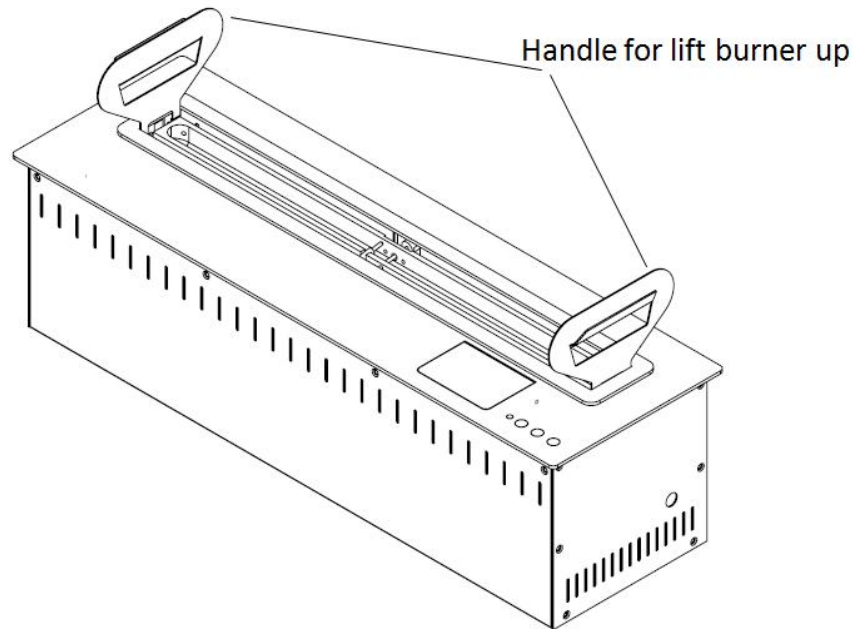

Ideal Location

For optimal safety and performance, the best location for your Bio Flame burner is:

- In a spacious, open area at least 1500mm (59.1 inches) away from any combustible materials, such as curtains, wallpaper, or veneer.
- On a level floor, on a non-combustible material.
- Within a firebox constructed from non-combustible materials like steel, concrete, brick, or natural stone.
- Not installed directly beside or near wallpaper, laminate, veneer, or any unsuitable surface (heat may affect the material). refer to the product specification of wallpaper, laminate, veneer, or glue for heat tolerances.

Burner Efficiency & Ventilation



The Bio Flame Burners operate without the need for any permanent fixture or fitting, such as a flue for ventilation or a fixed utility for fuel supply. To ensure sufficient ventilation, please make sure to adhere to the Minimum Room Size per burner shown in the table below. These ventilation requirements must always be met.

The table below outlines the efficiency specifications for each burner. Please be aware that these values are indicative and may vary depending on the installation and the quality of the purchased fuel.

Product name	Fuel Capacity (L)	Burning Time (Hrs.)	Heat output (BTU)	Flame length (mm)	Heats on average (room size)	Fuel Consumption	Min Room Size (per burner)
18" RC Burner	2	3.3-4	2600W ~ 3300W	329	40-50m ²	2.00 H/L	40 m ²
24" RC Burner	3.6	6-7.2	2600W ~ 4800W	482	50-60 m ²	2.00 H/L	50 m ²
30" RC Burner	5.4	7.2-9.8	2600W ~ 6000W	634	60-70 m ²	1.80 H/L	60 m ²
38" RC Burner	7.2	7.2-12	3300W ~ 8000W	780	70-80 m ²	1.67 H/L	70 m ²
48" RC Burner	10.8	7.7-16.6	4000W ~ 10600W	1092	90-115 m ²	1.54 H/L	90 m ²
60" RC Burner	14.4	20-Aug	5300W~12000W	1396	120-140 m ²	1.40 H/L	120 m ²
72" RC Burner	18	24-Aug	5300W~15000W	1701	150-160 m ²	1.33 H/L	150 m ²
84" RC Burner	21.6	27-Sep	5300W~16000W	2005.8	170-190 m ²	1.25 H/L	170 m ²
96" RC Burner	25.2	8.4-28	5800W~18550W	2310	200-220 m ²	1.11 H/L	200 m ²

Required Reading Before Use

Follow the instructions step-by-step before filling your burner.

- Press the power button only as instructed.
 - Press the button once to initiate the burner (only the burner and not the flames)
 - Press the button a second time (when instructed) to initiate the pilot and fuel flow.
 - **NEVER PRESS THE BUTTON A THIRD TIME.**
- During initial use, allow the pilot to become red and fuel to drip into the combustion tray for approximately two (2) minutes without pressing the power button again.
- The burner is equipped with a ten-minute safety feature, indicated by flashing power and arrow buttons for one minute. Wait ten (10) minutes after powering off before using it again.

Filling The Burner

The SMART Burners need a minimum of fuel level to work, please see the chart below:

PRODUCT NAME	MIN. FUEL LEVEL
18" RC Burner	1L
24" RC Burner	2L
30" RC Burner	3L
38" RC Burner	4L
48" RC Burner	5L
60" RC Burner	6L
72" RC Burner	7L
84" RC Burner	8L
96" RC Burner	9L

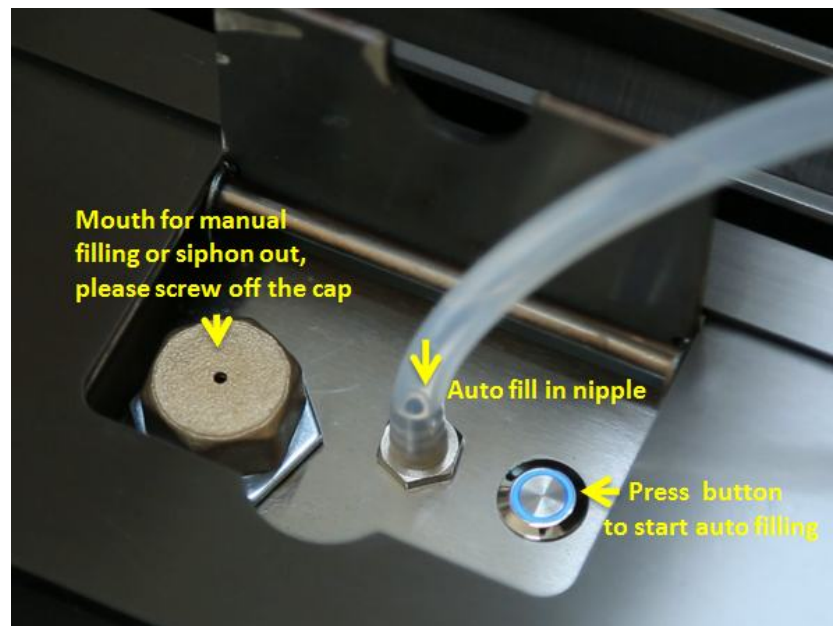

Automatic Fill

1. Ensure the burner is connected to the power supply.
2. Press the fuel door located on the front right-hand side.
3. Insert one end of the fuel hose into the fuel tank nipple and the other end into the bottle of ethanol fuel.
4. Press the button illuminated in blue to start filling. The process stops automatically when done.
5. Remove the hose carefully and clean up any spilled fuel.
6. Close the fuel door.
7. Press the power button twice within ten seconds to ignite the burner.

Manual Fill

1. Open the fuel door on the right-hand side.
2. Remove the gold-colored cap on the far left.
3. Use a funnel to pour the fuel into the tank. Stop when the blue light next to the filling hole turns off.
4. Shake the funnel before removing to prevent spills, then wipe up any spilled fuel.
5. Screw the gold cap again and close the fuel door.
6. Press the power button twice within ten seconds to ignite the burner.

NOTE: If both green arrows are flashing along with one long and one short beep, this indicates that the fuel has not reached the minimum trigger level.

Flame Size Adjustment

Once the flame covers the entire length of the combustion tray, you can adjust its intensity to your preference. Press the "UP" arrow on the burner casing or remote control to increase the flame's intensity or press the "DOWN" arrow to decrease it. The Smart Burner Series offers six adjustable heat settings: On, Flame Size 1, Flame Size 2, Flame Size 3, Flame Size 4, and off.

Turning Your Burner OFF

To extinguish the flame, press the power button on the burner casing or remote control once.

- Upon pressing the power button, the pump will stop sending fuel into the combustion tray.
- The green power button and arrows will illuminate to confirm that the burner has been powered off.
- The remaining fuel in the combustion tray will burn off, which may take a few minutes after powering off the burner.

NOTE: This burner is equipped with a ten-minute safety feature. The power and both arrow buttons will flash for one minute, indicating non-response until the temperature reaches a safe level. Once the burner is powered off, you must wait ten minutes before using it again.

Child Lock (Optional)

By default, Child Lock will be activated when the fireplace is powered on.

To unlock:



OPTION 1

Press and hold the power button for 3-9 seconds until you hear a beep sound.



OPTION 2

Press the home button on the remote twice.

Fine Adjusting

In case the flame does not reach the satisfied level, please try fine adjusting as follows:

Fine adjusting the first chamber

1. Steps to decrease flame size.

- a. Ensure the flame is at its largest setting (4)
- b. Press and hold the "UP" arrow button on the fireplace while pressing the home button on the remote twice, then press the decrease button once.

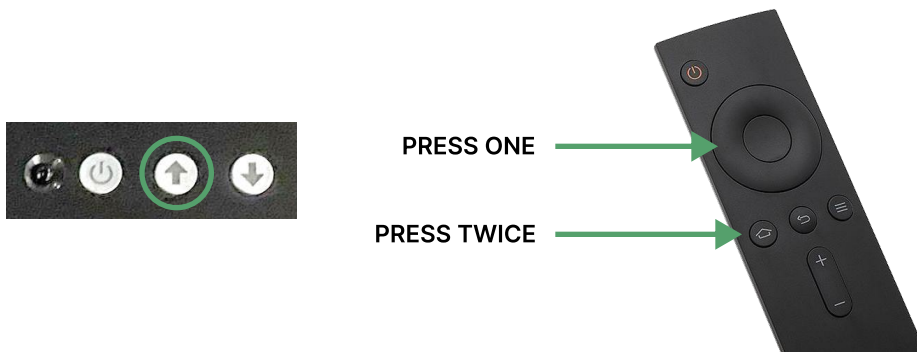

1. Steps to increase flame size.

- a. Ensure the flame is at its largest setting (4)
- b. Press and hold the "UP" arrow button on the fireplace while pressing the home button on the remote twice, then press the increase button once.



Fine adjusting the second chamber (only applicable for burners with two chambers)

In case the flame does not reach the satisfied level, please try fine adjusting as follows:

1. Steps to decrease flame size.

- Ensure the flame is at its largest setting (4)
- Press and hold the "UP" arrow button on the fireplace while pressing the manual button on the remote twice, then press the decrease button once.

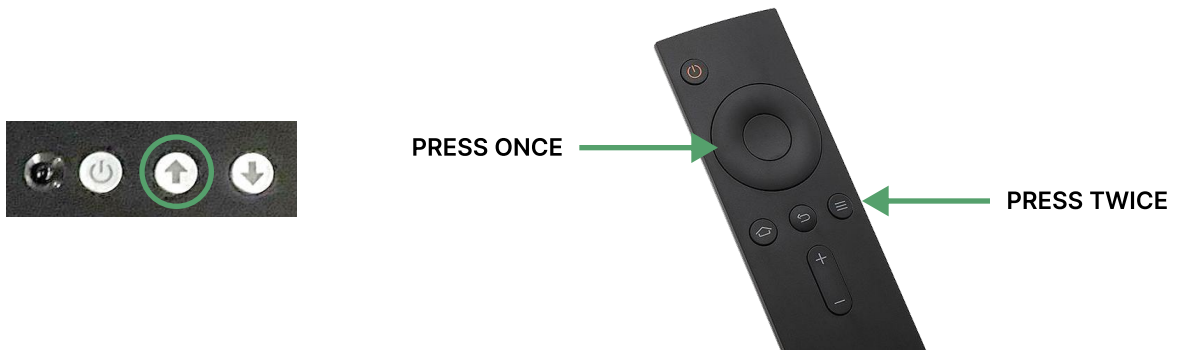

1. Steps to increase flame size.

- Ensure the flame is at its largest setting (4)
- Press and hold the "UP" arrow button on the fireplace while pressing the manual button on the remote twice, then press the increase button once.



Level the combustion tray

Level the combustion tray

If the flame remains at one end on the large flame setting for more than 10 minutes, it indicates that the combustion tray is not properly leveled.

Please turn off the burner and wait for it to cool down. Once cool, use a screwdriver to adjust the screw, either tightening (to lower) or loosening (to raise) the end of the chamber. Refer to the illustration for guidance.

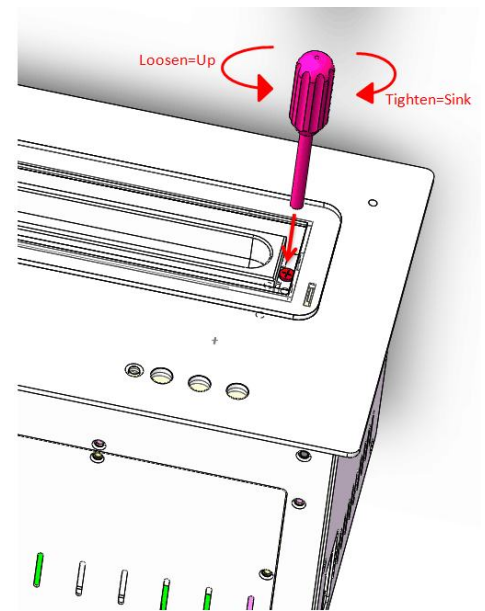

WARNING: Wait until the burner has cooled down before performing this action.

Siphon Fuel Out of Burner

When storing or transporting the burner, ensure all fuel is emptied from the unit. Use the siphon hose with the black ball to remove the fuel, following the instructions below. Keep this siphon hose for the lifetime of the burner in case it is needed in the future.

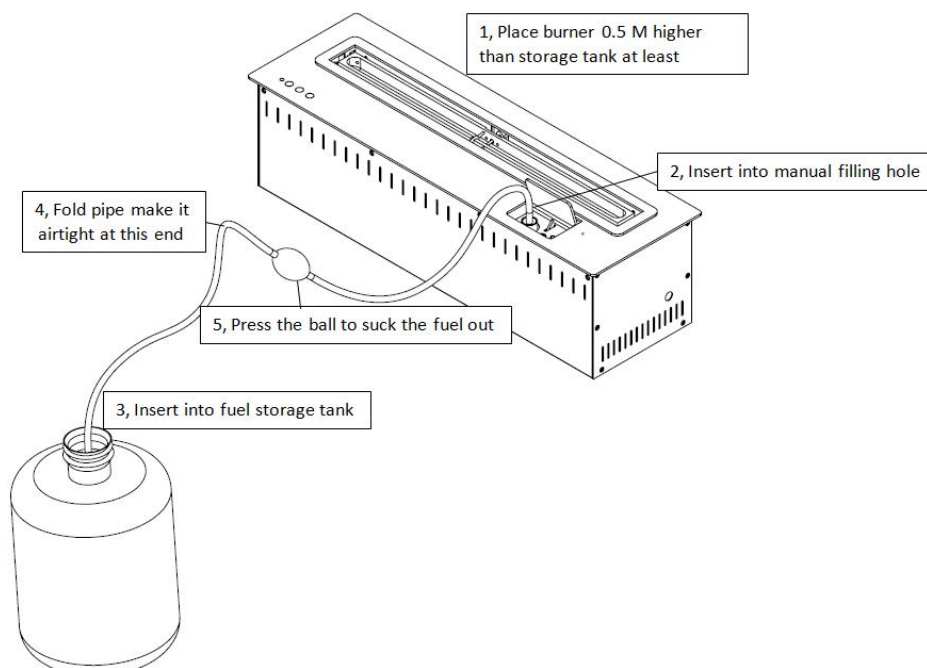

Cleaning your Fireplace

One of the questions we often receive is how you clean your bioethanol fireplace and whether it is necessary to clean it.

Do I Need to Clean My Bioethanol Fireplace?

Yes, you should clean your bioethanol fireplace occasionally, if you wish to have a beautiful and well-functioning fireplace for many years to come. A bioethanol fireplace does not leave residue, which means that maintenance is much simpler when compared to a traditional fireplace.

How to Clean My Bioethanol Fireplace?

It is very simple to do and does not require much effort or time. First, make sure the burner is off, cold, and has no fuel in it.

- For the surface of the fireplace, use a soft, damp cloth.
- Please do not wipe the burning tray for black units, as it can turn red and is irremovable.
- For the burning chamber:
 - Stainless steel and black colors: Use a soft washing sponge. We recommend that you dip the sponge in some ethanol fuel and wipe it by following the stainless-steel lines.
 - Make sure not to touch the lightning rod when cleaning it as it is very fragile.

Can I use anything to clean it?

No, please do not use harsh sponges when cleaning your bioethanol fireplace. Only a damp cloth or soft fabric for the surface (we recommend using a microfiber cloth) and a soft sponge for washing the burning chamber.

DON'T use stainless steel wool.

How often should I clean it?

It depends on how much you use it and how clean and tidy is the area around it. We recommend cleaning your bioethanol fireplace at least monthly if using it regularly.

IMPORTANT: Please note that the burner may experience a heat-staining effect around the flame opening. This is a normal part of the heating process that cannot be avoided. Please do not use stainless steel cleaning agents, as these leave residue and may worsen the stain.

Other Care Considerations:

Please consider the following when using your bioethanol fireplace.

Is there a maximum of continued hours of use?

There is no limit to burning hours as long as you keep fuel in the tank.

What type of fuel can I use?

Only bioethanol fuel - ensure the fuel is intended for indoor use with ethanol fireplaces. We recommend buying single-liter bottles of bioethanol fuel and using a funnel to avoid any spilling.

Can I add water to the fuel?

We do not recommend diluting the fuel with water. The flame output will not be good as it will not reach the end of the burner. It also causes an accumulation of fuel in the burning chamber, which can be dangerous.

What happens if I overfill the tank?

Please always fill the tank up to the MAX line. Overfilling can cause the unit to malfunction and make it difficult to extinguish the fire.

IMPORTANT: Always refuel when the fireplace is off and cold. Refueling a hot fireplace is a safety hazard and can cause accidents like a burst of flame when lighting the fire.

If your Burner is presenting an issue, please read below:

- **Check the Ignitor:** If the ignitor does not turn red, it may be loose or broken. Check for any loose or broken parts and tighten or replace them as needed.
- **Check the Fuel Pipe and Pump:** If there is no fuel coming out of the fuel pipe, check if there is fuel flowing through the plastic house. If not, it may be a pump problem, which is the most common problem. In such a case, refer to the user manual for instructions on how to troubleshoot the problem.
- **Wait for 2-3 minutes** for the fuel to spread evenly every time you click a button for flame settings.
- **Check the Temperature Sensor:** If the flame spreads across the burner and then narrows down to the center of the burner, bend the temperature sensor upwards with a pair of pliers. If this does not solve the problem, it may be a motherboard issue.
- **Check the Power Supply:** If the motherboard does not have a light, it means there is no power to the motherboard. It may be an adapter or power module problem. Check the connection and power supply.
- **Check the Wi-Fi Sensor:** If the Burner is not shown on the Wi-Fi list, it may be a sensor issue. To confirm, follow the next steps:
 - First check if the Wi-Fi name starting from “XPG...” shows on the WLAN list.
 - If it does not, check the Wi-Fi card has a flashing light. Plug the sensor, plug it back in, unplug power, wait 4 seconds, plug, click the buttons on the remote control three times to reset the Wi-Fi connection, and check again if the Wi-Fi name pops up. If it still does not work.
 - If you are still unable to connect, take a screenshot video and send it to the support team at hello@thebioflame.com for help.
- **Check the Remote Control:**
 - Ensure the battery is properly installed.
 - Ensure that the stainless-steel ground is on top of the battery.

- Beep codes:

Warning Beeps	Error	Solution
One short beep: B,B,B,B,B,	CO2 density reaches warning level	Ventilate the room as soon as possible
Two short beeps: BB,BB,BB,BB,BB	Overheating burning chamber	Shut down unit and wait for it to cool down
Three short beeps: BBB,BBB,BBB,BBB,BBB	Overheating fuel tank	Leave the burner shut off and wait for it to cool down
Four short beeps: BBBB,BBBBB,BBBBB,BBBBB,	Burner is not level	Adjust the burner to level and restart the unit
One short beep with One long beep: BB~~,BB~~,BB~~,BB~~,	Fuel shortage	Shut down the unit, wait for it to cool down, then refill with more fuel
Two short beeps with One long beep: BBB~~,BBB~~,BBB~~,BBB~~	CO2 warning	Ventia
Three short beeps with One long beep: BBBB~~, BBBB~~	Ignition failed or fire extinguished. Burner will stop working within 30 seconds.	Restart the burner after it cool down
Four short beeps with One long beep: BBBBB~~, BBBBB~~	(When filling manually only) Fuel tank reached maximum capacity; the pump will stop automatically	Stop filling manually