

the bio Flame

84" FIREBOX DS

Installation Instructions

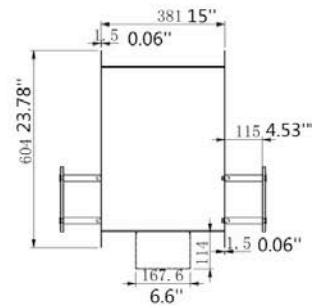

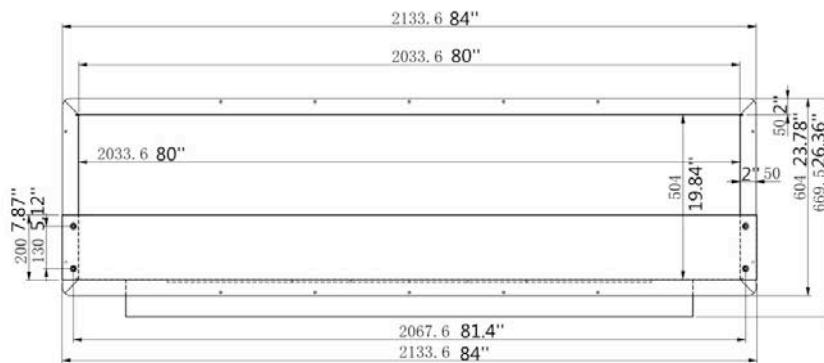
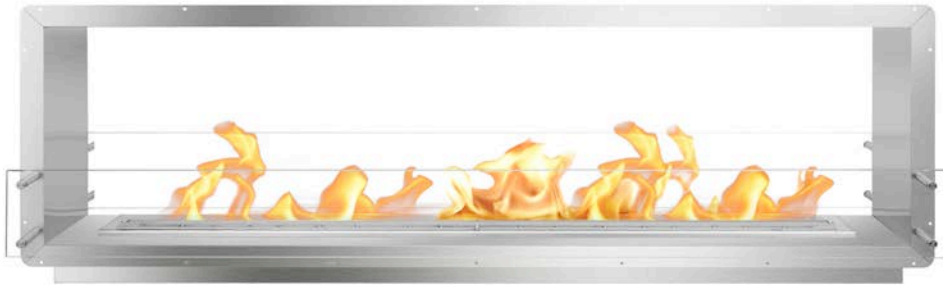
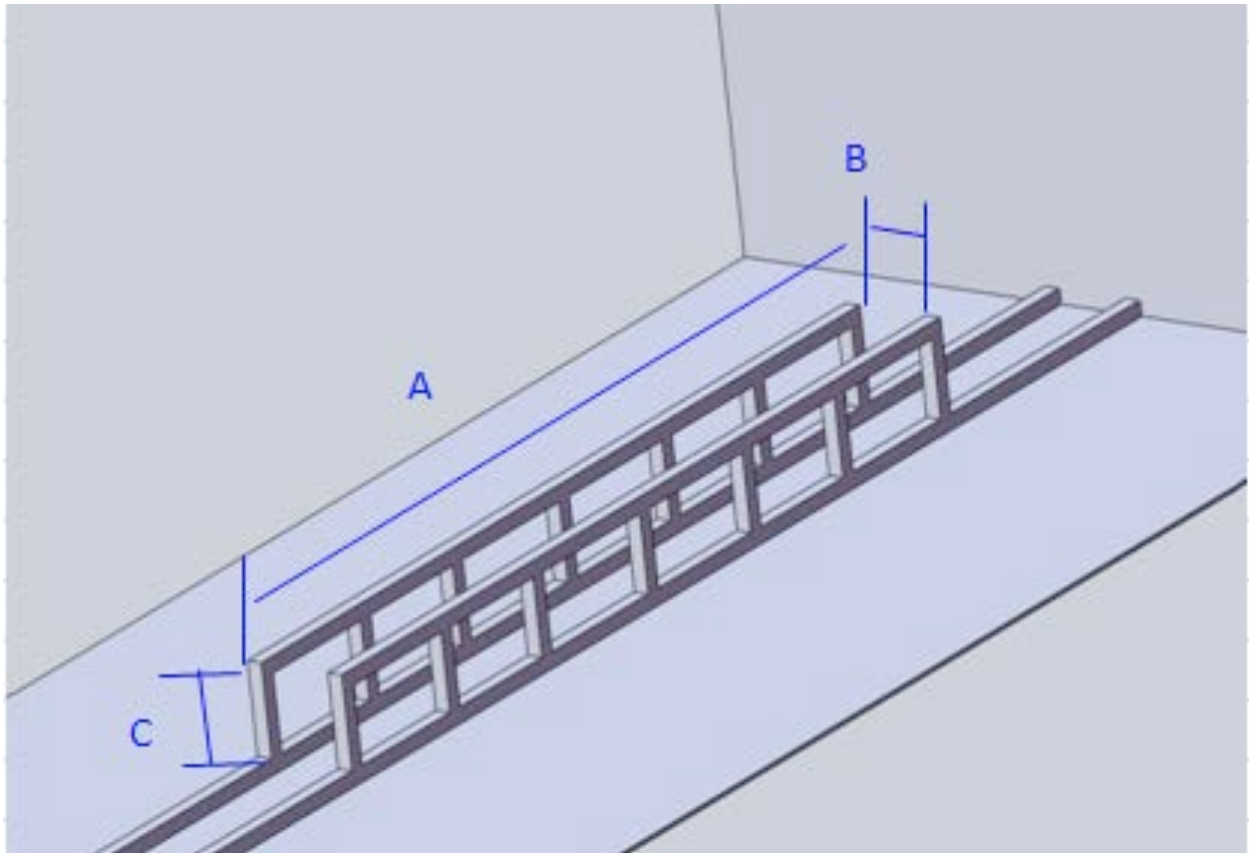

Non combustible materials must be used around the firebox! The Firebox cavity must be a lined with a minimum of 3/8" thick cement board.

A size: 2133.6mm (84") B size: 177.8mm (7") C size: 165mm (6.5")

1. Line the base with cement board and insert your Firebox into the base.
2. Make sure the firebox is centered

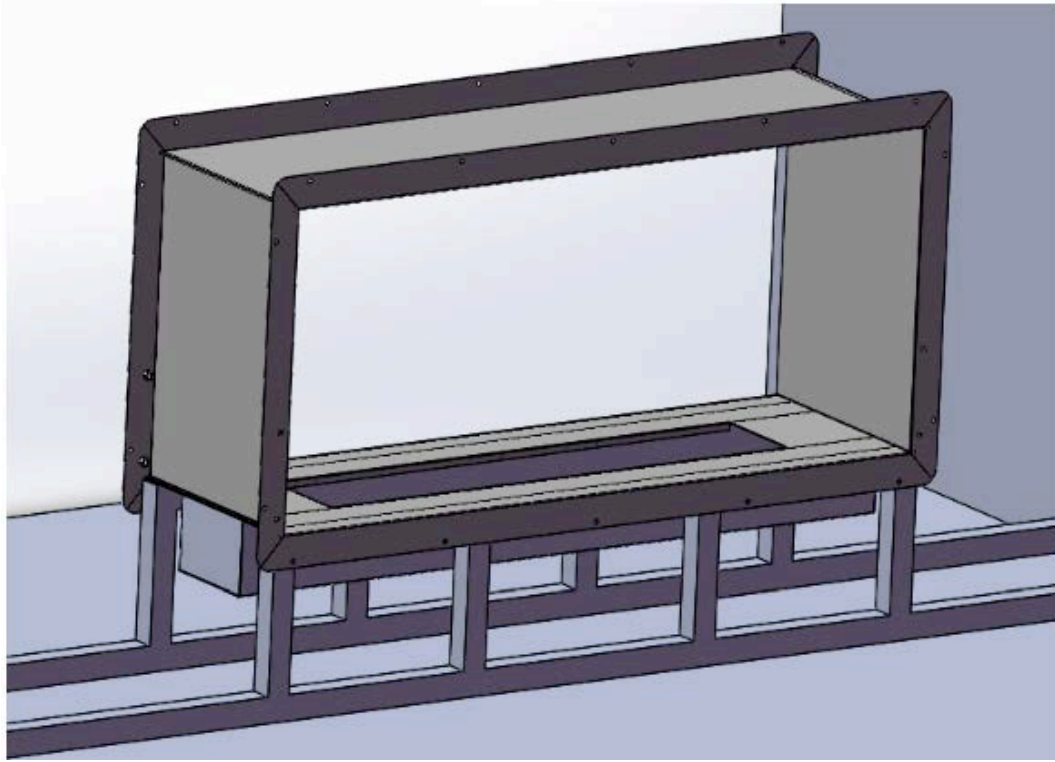

3. Continue building the wall, ensuring that there is a layer of cement board between the stud and your Firebox on all sides.

4. First stud on either side of the Firebox must be flush with the Firebox and flange

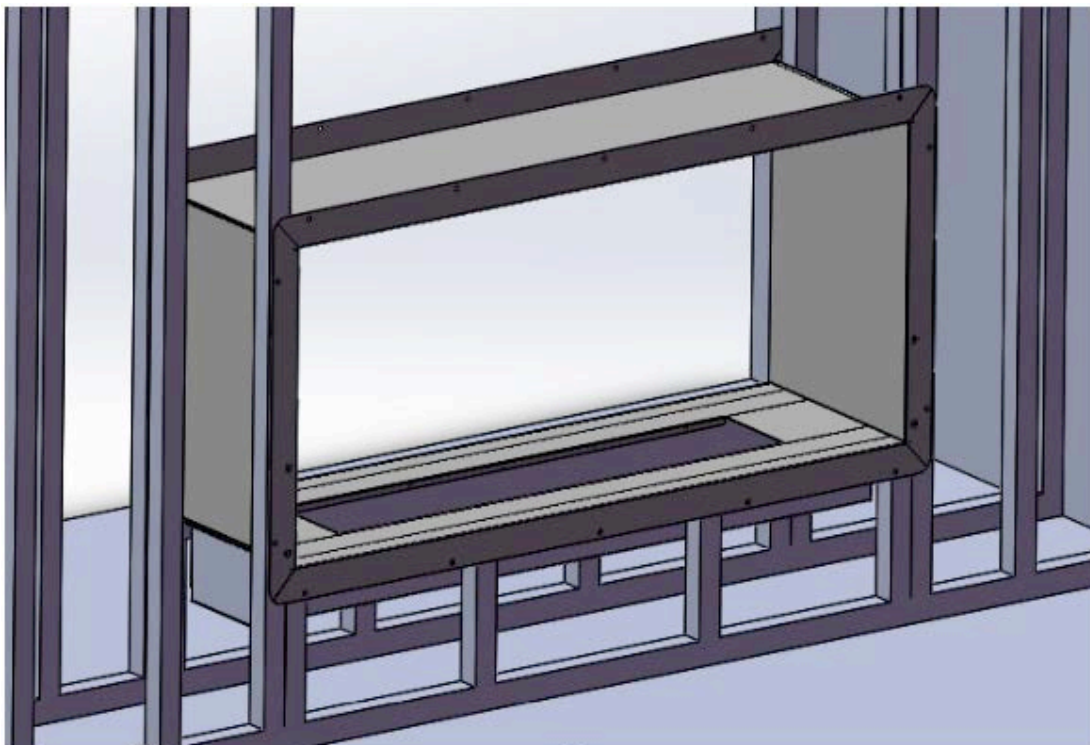

5. Install a stud horizontally on top of the firebox to be able to continue with the wall

6. Screw the top of horizontal stud directly to the Firebox brackets (use 0.5 inch metal zips)

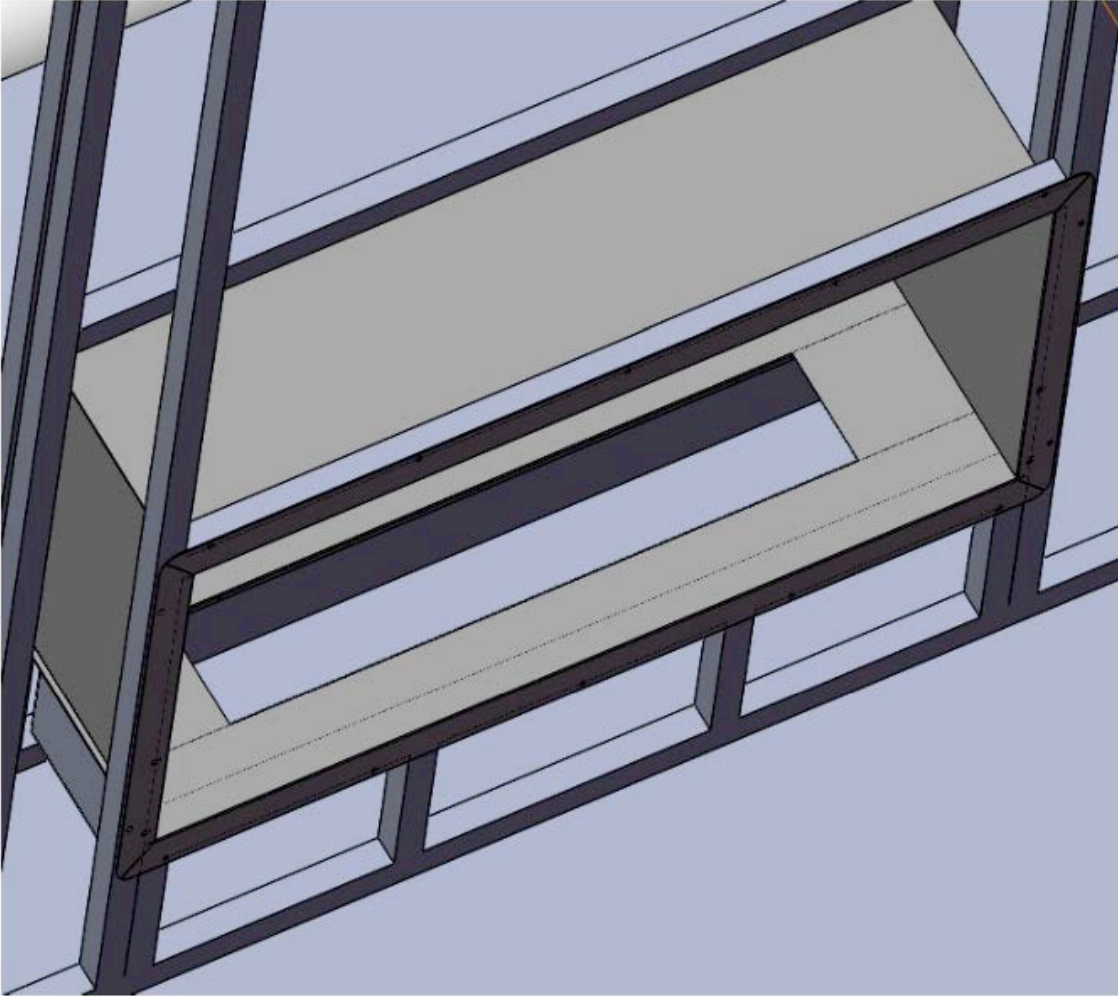

7. Continue building the wall

8. Support the firebox with screws around the flange into the stud

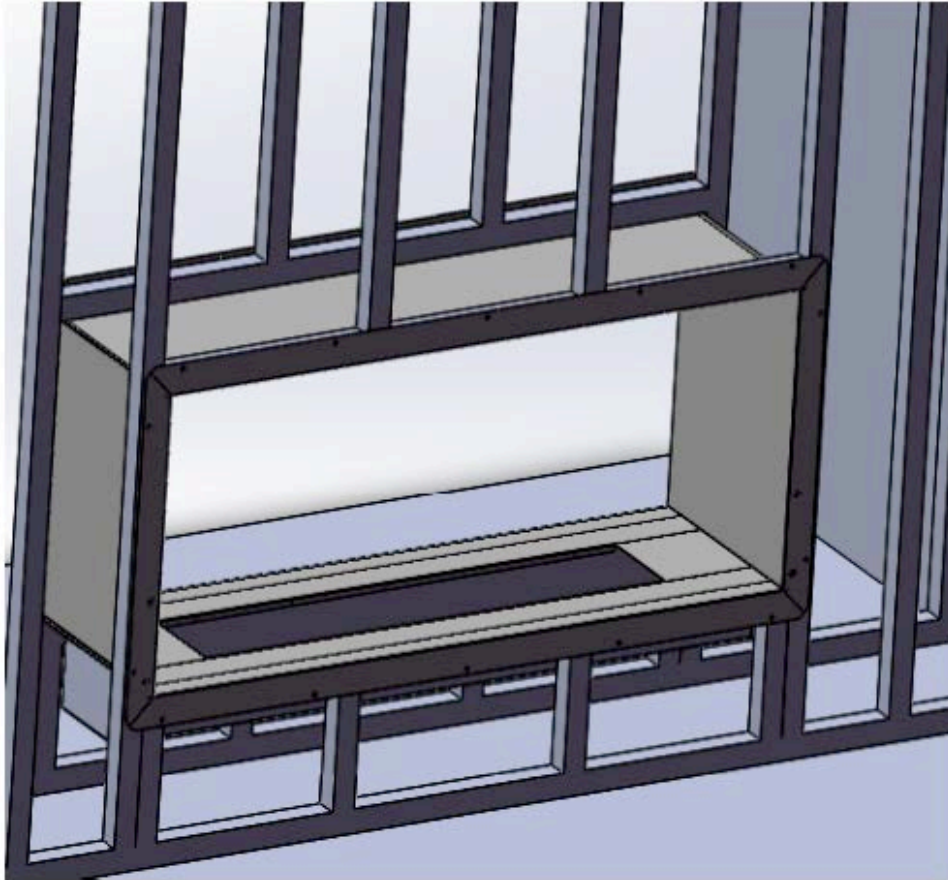

- 9. Cover the firebox with sheetrock, wonderboard, stones ,etc
- 10..Mount the glass into firebox

