



Cloud Intelligence

THANK YOU FOR CHOOSING LITEDEER HOMES  
SMART PRODUCT

## 3D Atomized Fireplace Operating Instruction

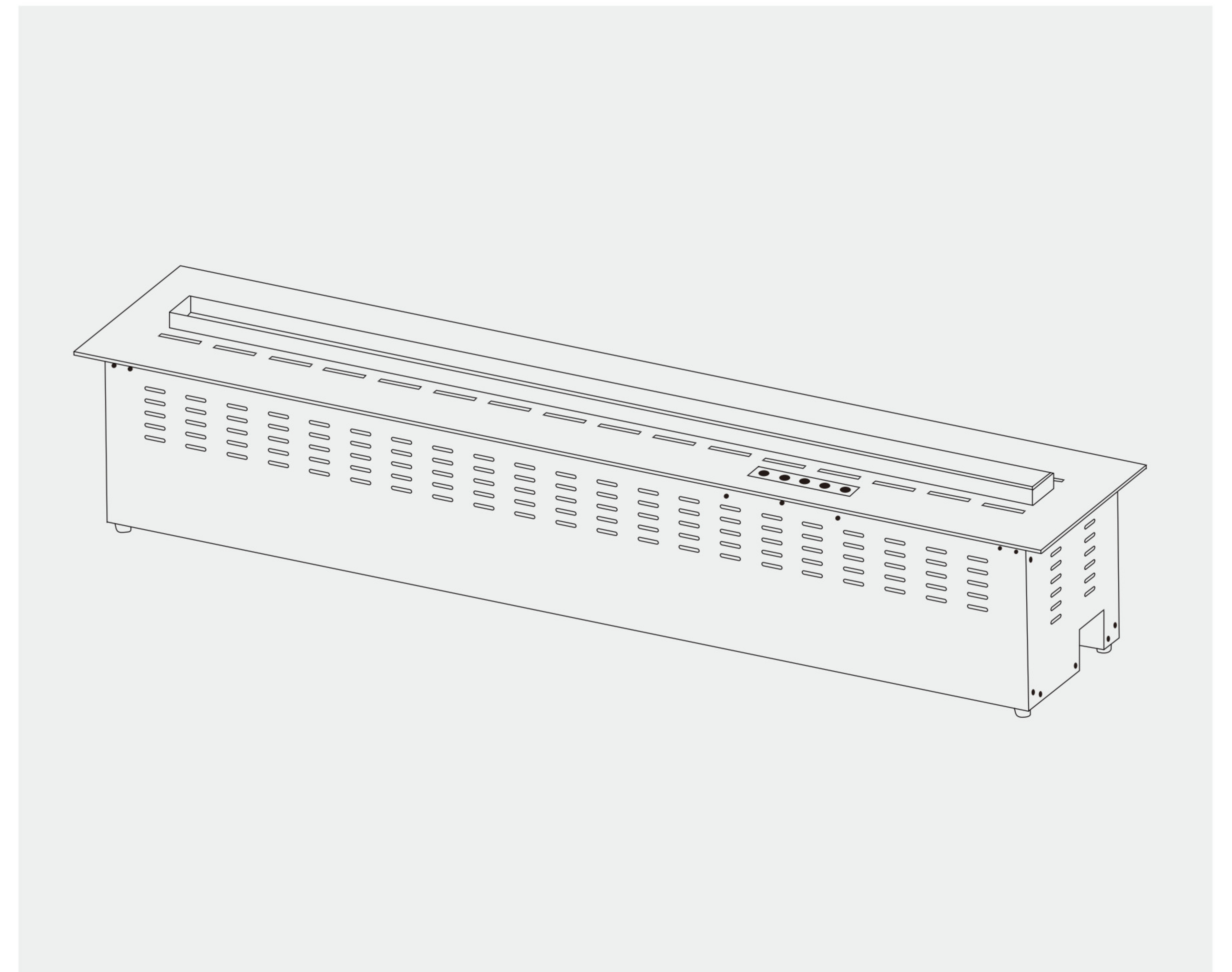

wifi inteligent control Quick Start Guide

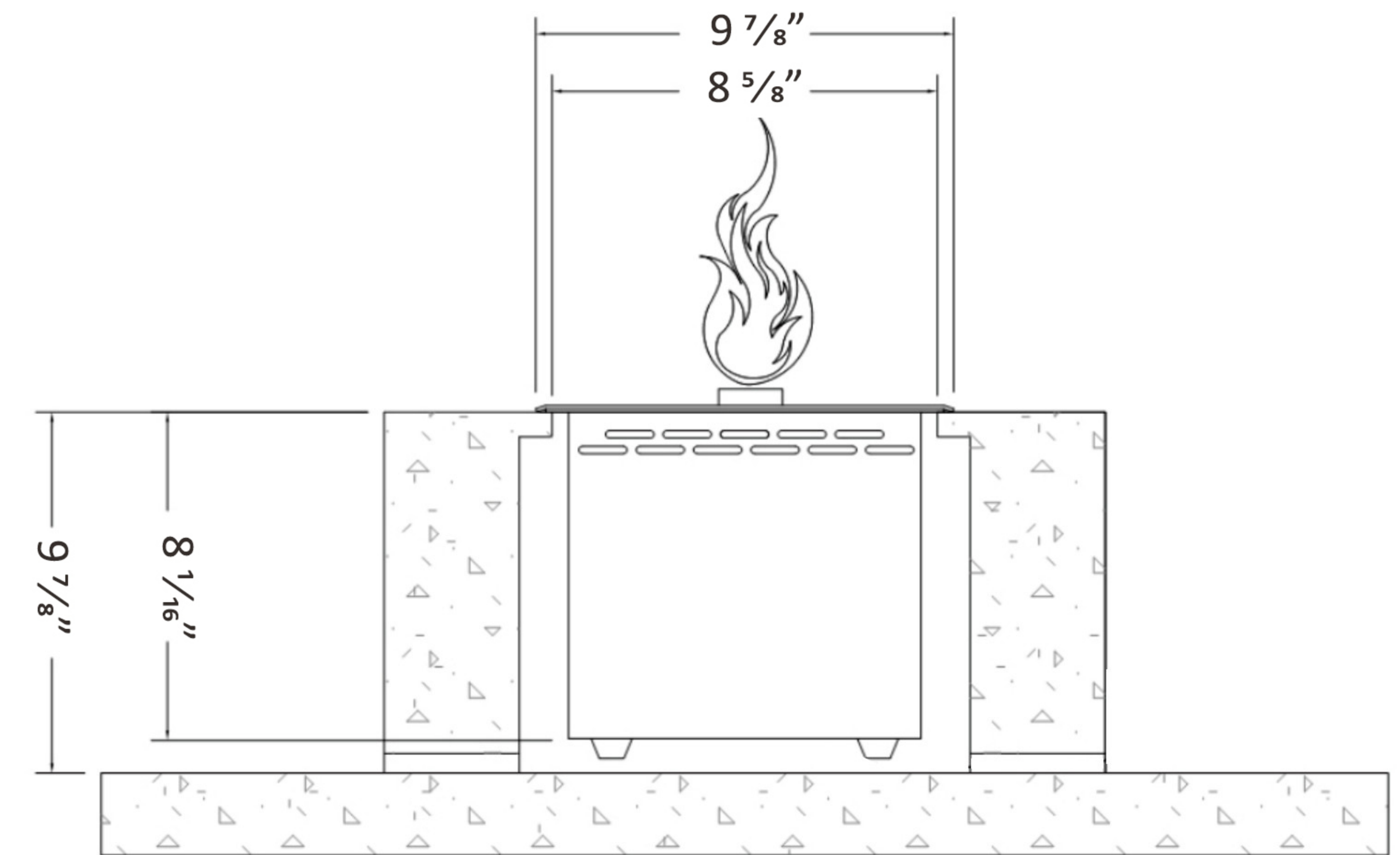
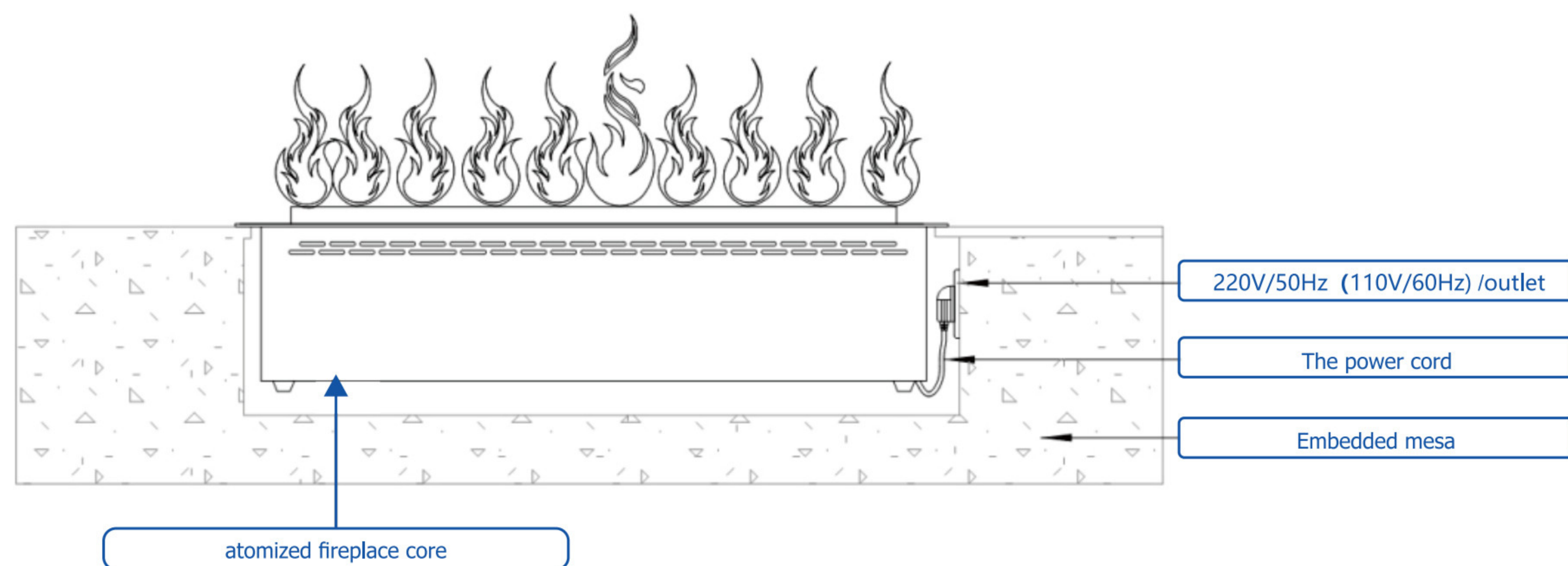
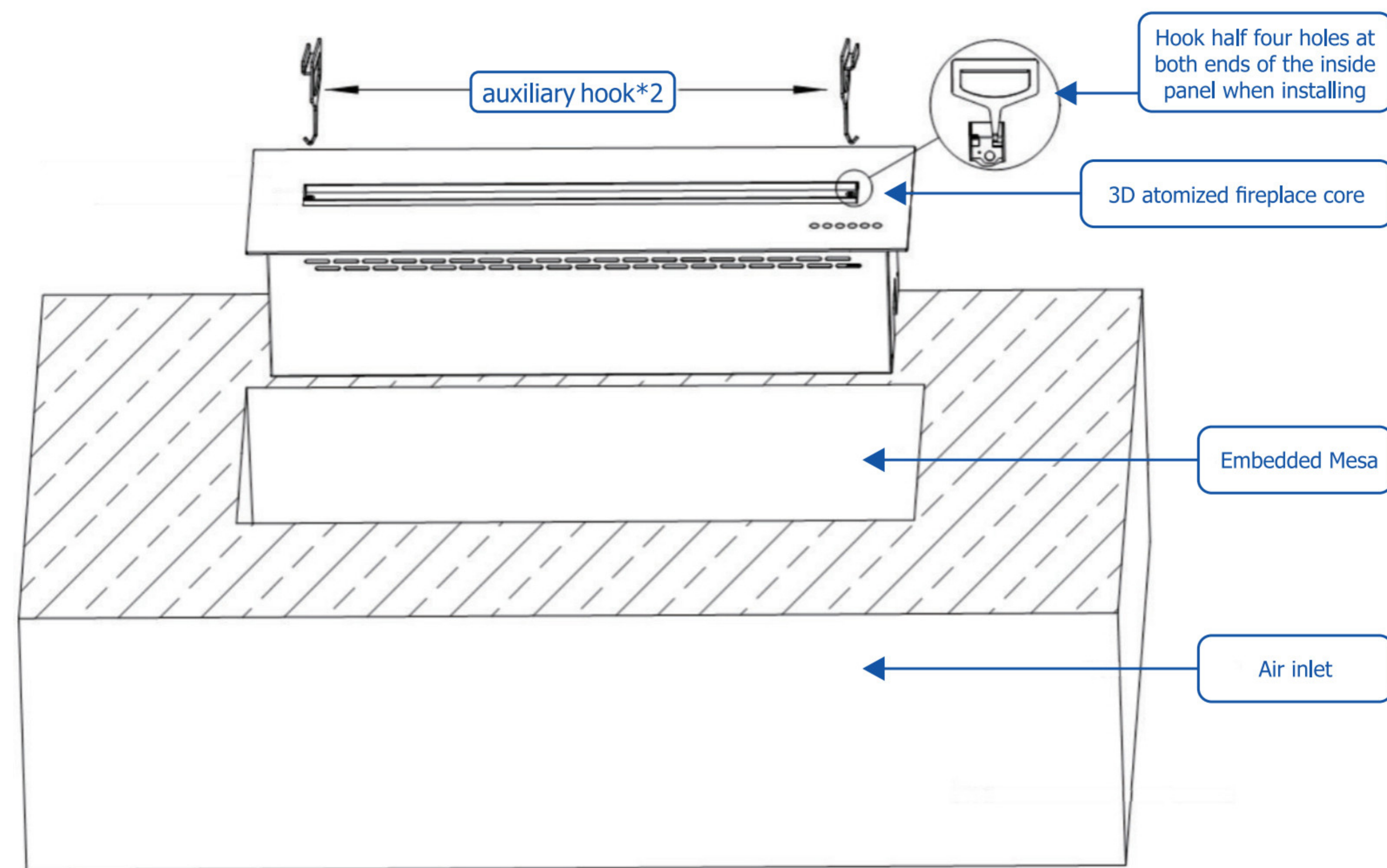

Thank you for purchasing this fireplace, Please read the instructions before using and use them correctly, especially the "Safety Precautions". After reading, please keep the instruction for reference at any time.

## Installation instructions



- Remove the atomized fireplace from the package.
- Plug in the power cord.
- Put it on the built table.
- Take out the water pipe, insert the water filling port and press the water adding button .
- If the fireplace is not used for a long time, it is necessary to discharge the internal pure water. When the fireplace is turned on, plug in the water filling hose. Press this button on the remote control for five consecutive times to start the drainage pump to discharge the water. .

# 3D Atomized Fireplace Operating Instruction

## Precautions For Placement

- In stable locations, choose a location with good air.
- Many products enter the air from the bottom, please keep the air outlet unimpeded.
- This product is suitable for embedded installation only.

## Safety Precautions

- Please read the "Safety Precautions" carefully before using the product and use the product correctly.
- The purpose of this statement is to allow consumers to use the product safely and to prevent unnecessary harm to themselves or others.
- According to the severity of the failure, it is divided into "warning" and "attention".

## Attention

- Inflammable, explosive and other dangerous goods are not allowed around the machine.
- When not in use for a long time, please cut off the power and unplug the plug, and discharge the water in the chassis.
- Not wipe the unit with volatile oil or chemical reagents.
- When the product is in use, the fog outlet and the surrounding surface are in high temperature.
- Do not touch it with your hands.

## Product parameters

- Rated voltage: 120-240V (100-110V)
- Rate: 50Hz(60Hz)
- Rated power: 220-900W

## Warning

- Non-professional technicians are not allowed to disassemble and repair the machine to avoid electric shock and injury. If you need repair, please take it to our appointed repair shop or contact the dealer.
- Remember that the air inlet should not be blocked, so as not to affect the projected flame effect.
- Not put your hand into the fog outlet to avoid scald.
- During maintenance, unplug the power socket (do not use wet hands to plug in and out of the power socket).
- Please do not scratch, process, force bending, drag, tie or squeeze the power cord. Otherwise, the power cord may be damaged, which may lead to fire and electric shock.
- Be sure to use 220V50Hz AC power supply.

## Dimensions

Model	L1	L2	Opening slotting Size (MM)	water add(L)	water C. (L)	NET (KG)	W (KG)	Package Size (MM)	M
ZVW40	43 1/4"	41 1/4"	42" X8 5/8" X9 7/8"	11	0.6~1.5	23	26.5	50" X12 5/8" X12 5/8"	carton
ZVW50	51 1/8"	49 3/16"	50" X8 5/8" X9 7/8"	13	0.6~1.5	27	31	58" X12 5/8" X12 5/8"	carton
ZVW60	62 15/16"	60 15/16"	61" X8 5/8" X9 7/8"	16	0.6~1.5	33	38	66" X12 5/8" X12 5/8"	carton

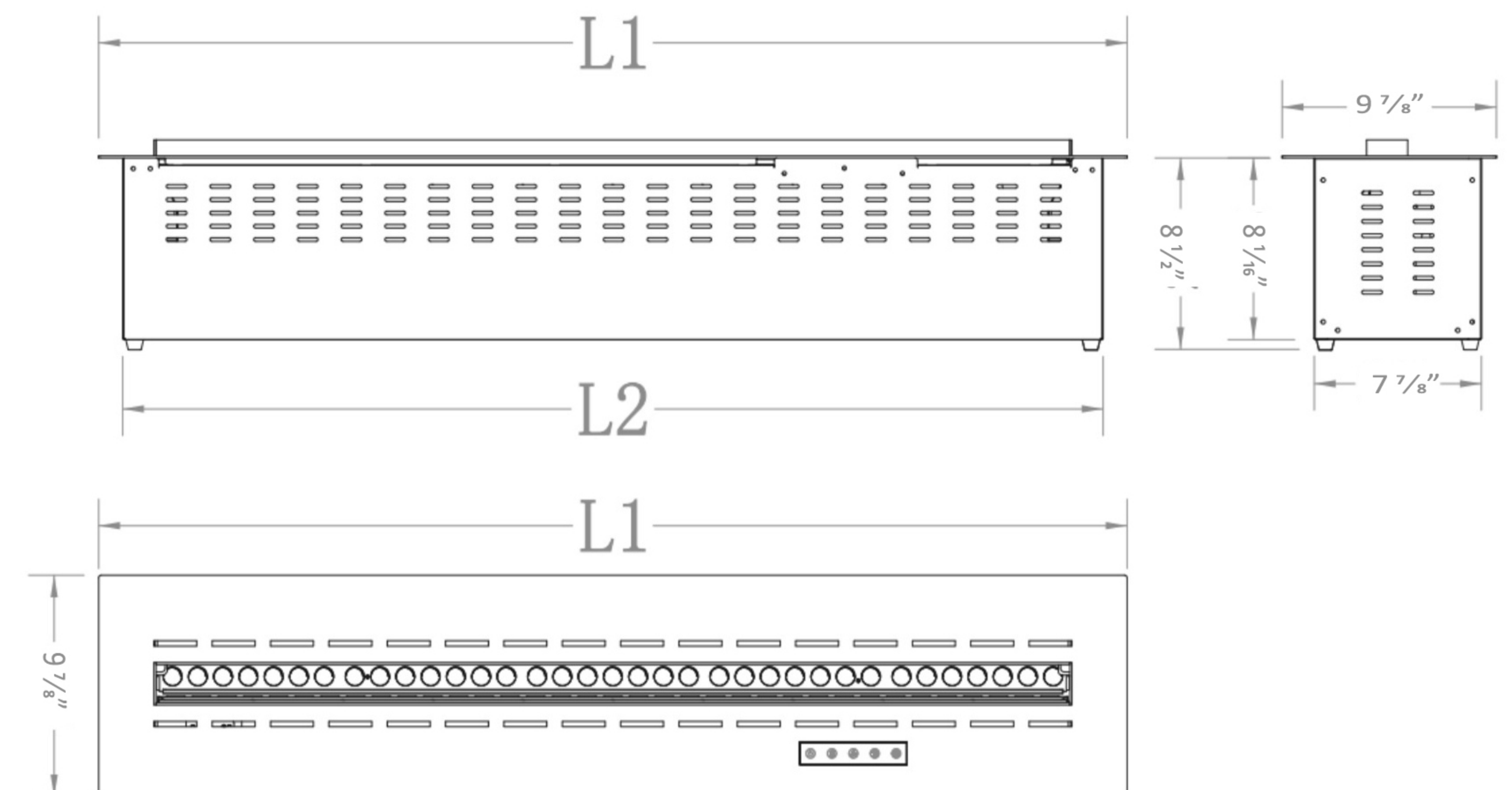

## Instructions for

### The Remote Control

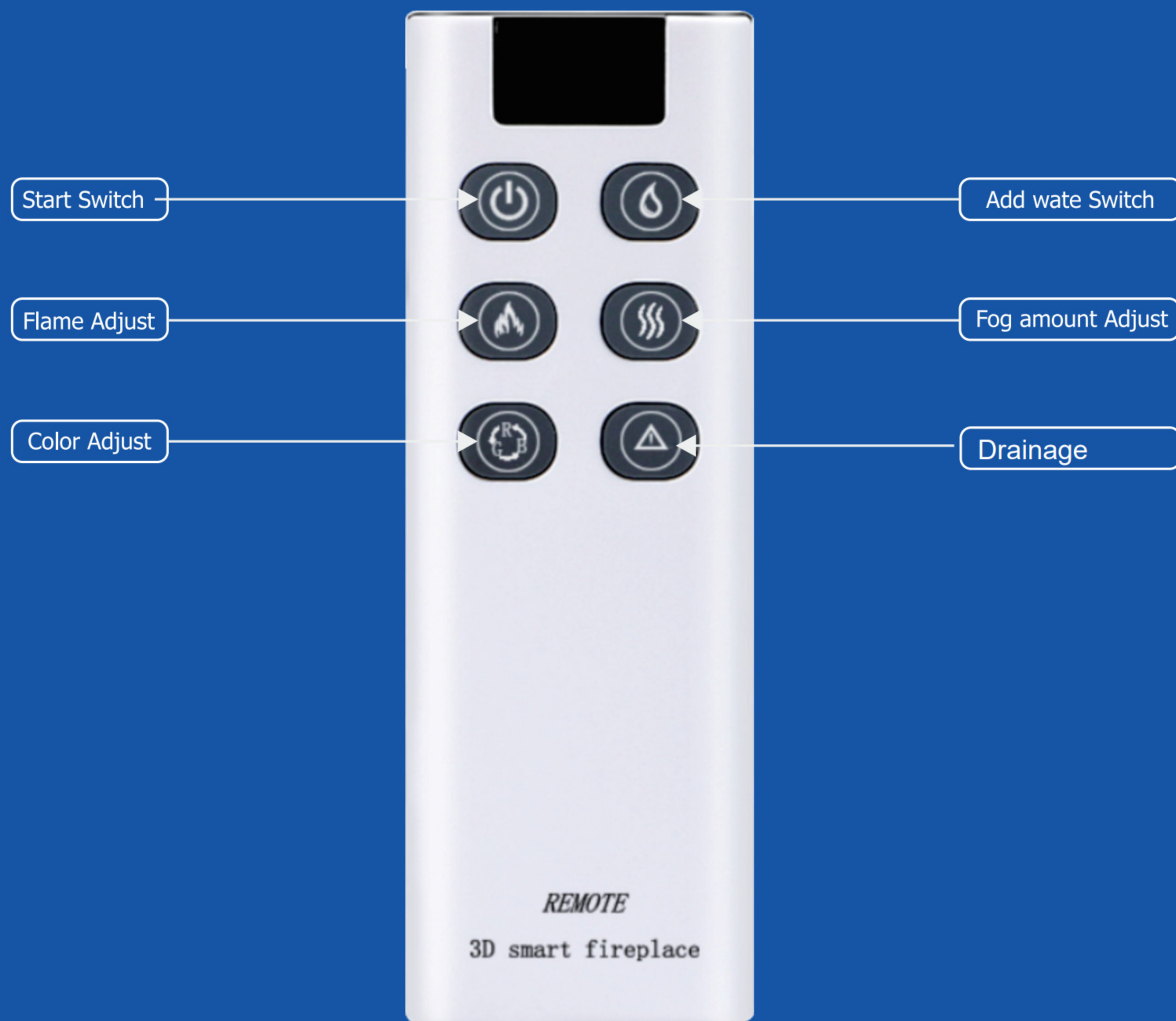

Battery: 23A 12V

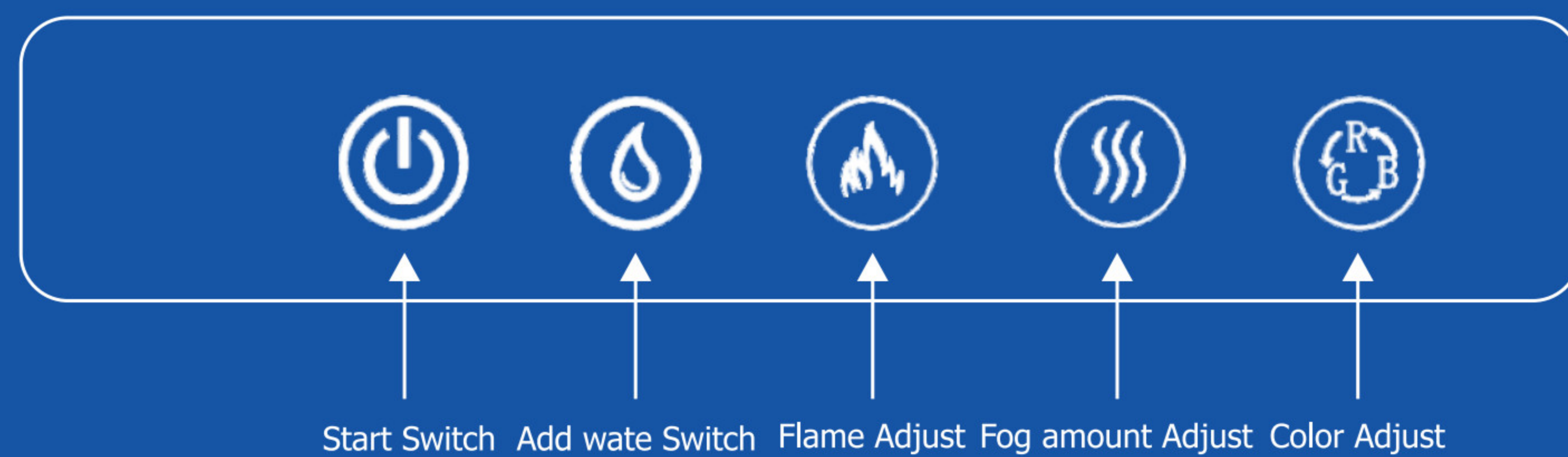

## Code for remote control

When the machine is on, long press the key for 5 to 8 seconds, and the led and led double flash will appear after that, release the button and enter the state of code matching. At this point, press any key of the remote control to complete the code.

## Clear code of remote control

When the machine is on, long press the key for 5 to 8 seconds to appear led and led double after flash, release the button, enter the automatic clearing code value and complete automatically.

## Wifi distribution network

When the machine is on, long press the key for 5 to 8 seconds to appear led and led double flash, release the button and wait for network configuration. When there is led single flash, it means that it enters the distribution mode; When led single flash, indicating access to the connected cloud; When led single flash, it means that the initial data of the connected cloud has been reported successfully.

## Insert the power plug into the 220V/50Hz (110V/60Hz)power socket.

- Start switch, system start later.
- Add water switch, when the water level is too low, need to add purified water.
- Projection flame adjustment, and the size of projection purified water.flame is adjusted in 5 different levels.
- Adjust the fog amount, and adjust the fog size in 5 blocks.  
Color adjustment, 7 color cycle optional.
- The drain switch is in the power-on state. Plug in the water filling hose. Press this button on the remote control for 5 consecutive times to start the drain pump and discharge the water.

### Troubleshooting method

The fault phenomenon	Check the project	Elimination method
The light is not bright	Whether the power is on	Open the power supply
	Whether the power plug has come of or short circuited	Plug or replace the plug
No flame	Whether to add purified water	Added purified water
	Is in the alarm state	Cancel the alarm

# wifi intelligent control Quick Start Guide

## Start setup

Please go to the Mobile APP Store, download the latest version of the "Cloud Intelligence" APP, or scan the QR code below to get it.



Domestic user



Overseas user

## Registering

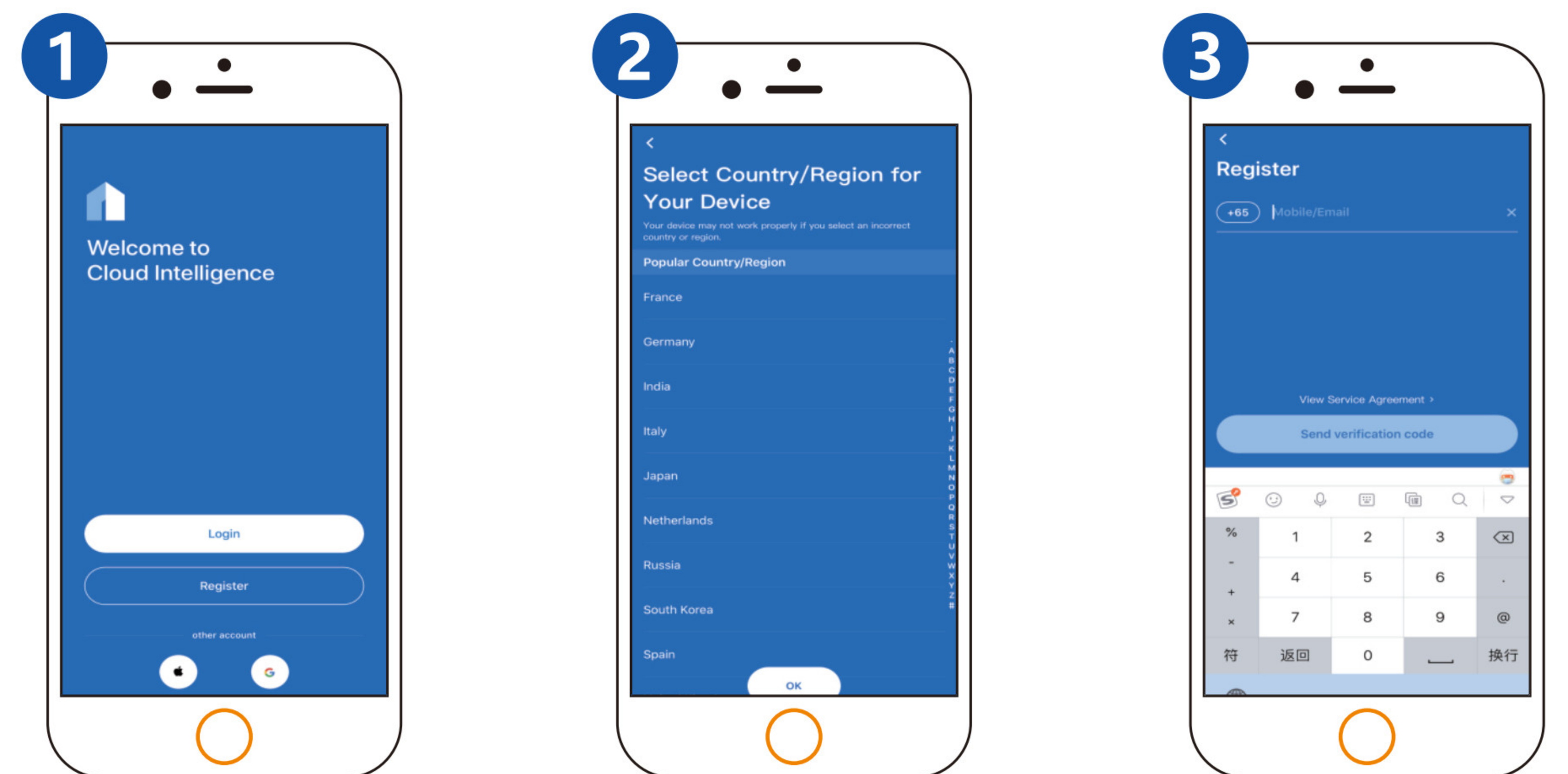

Open the "Cloud Intelligence" APP. According to the actual situation, the user can choose the country/region to use the device, and use the phone/email to register and log in.

## Configure the device to the network

You can add devices through "+" at the top right corner of the homepage of "Cloud Intelligence" App. You can directly click "+" to add, or use search, scan (QR code below), category search to add the device.







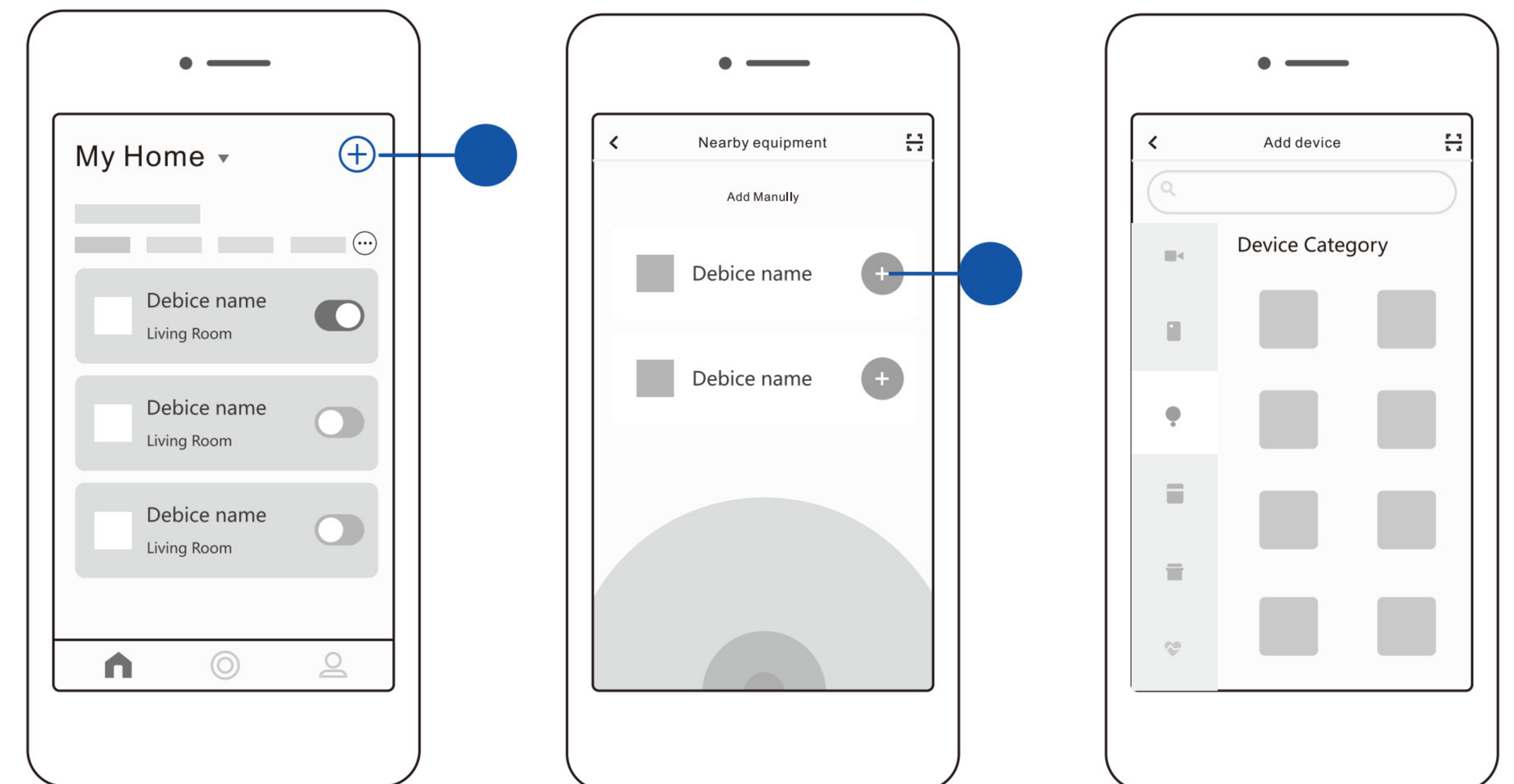

Domestic equipment  
with network code



Overseas equipment  
with network code



Locate the distribution network button on the device and start and complete the configuration according to the guidance of the distribution network.

Network distribution guide: When the power button is turned on, long press the power button  for 5-8 seconds. When the adding water button  LED and fog amount key  LED double flash occurs, release the button and then enter the distribution network state. Proceed to the next operation on the App to complete the network distribution. When  LED single flash, means into the network mode;  LED single flash, means to enter the connection cloud; When  LED single flash, the connection cloud successfully reports the initial data.

## Device control

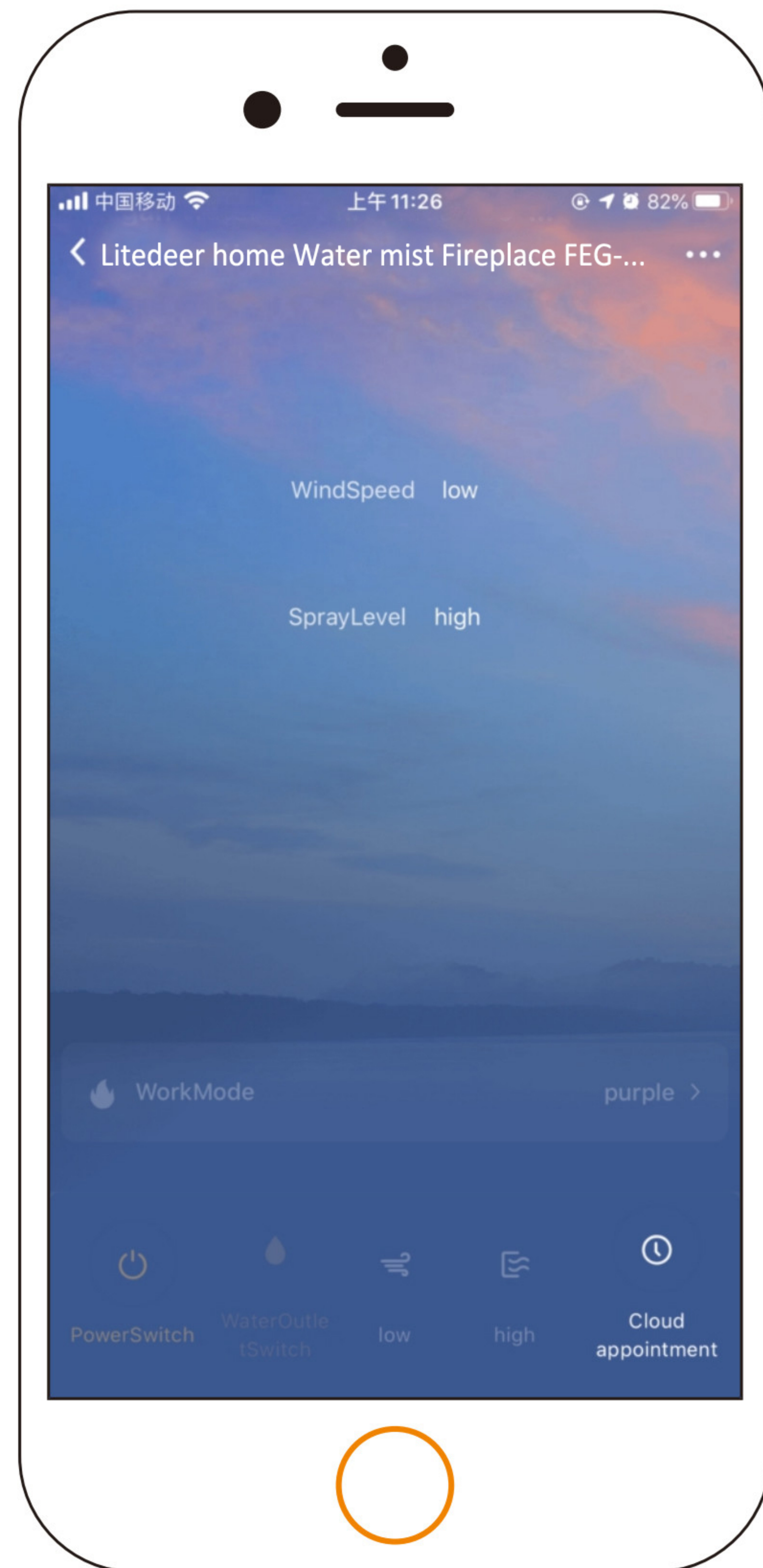

The homepage list contains all the smart devices you have added. Click to enter the device panel, which contains all the detailed operations of the device.



## Device control

Users can click "... " on the upper right corner of the device control page and then enter the device sharing page and share the device with family and friends. Shared users need to agree to the invitation in the Message Center to gain access to the device.

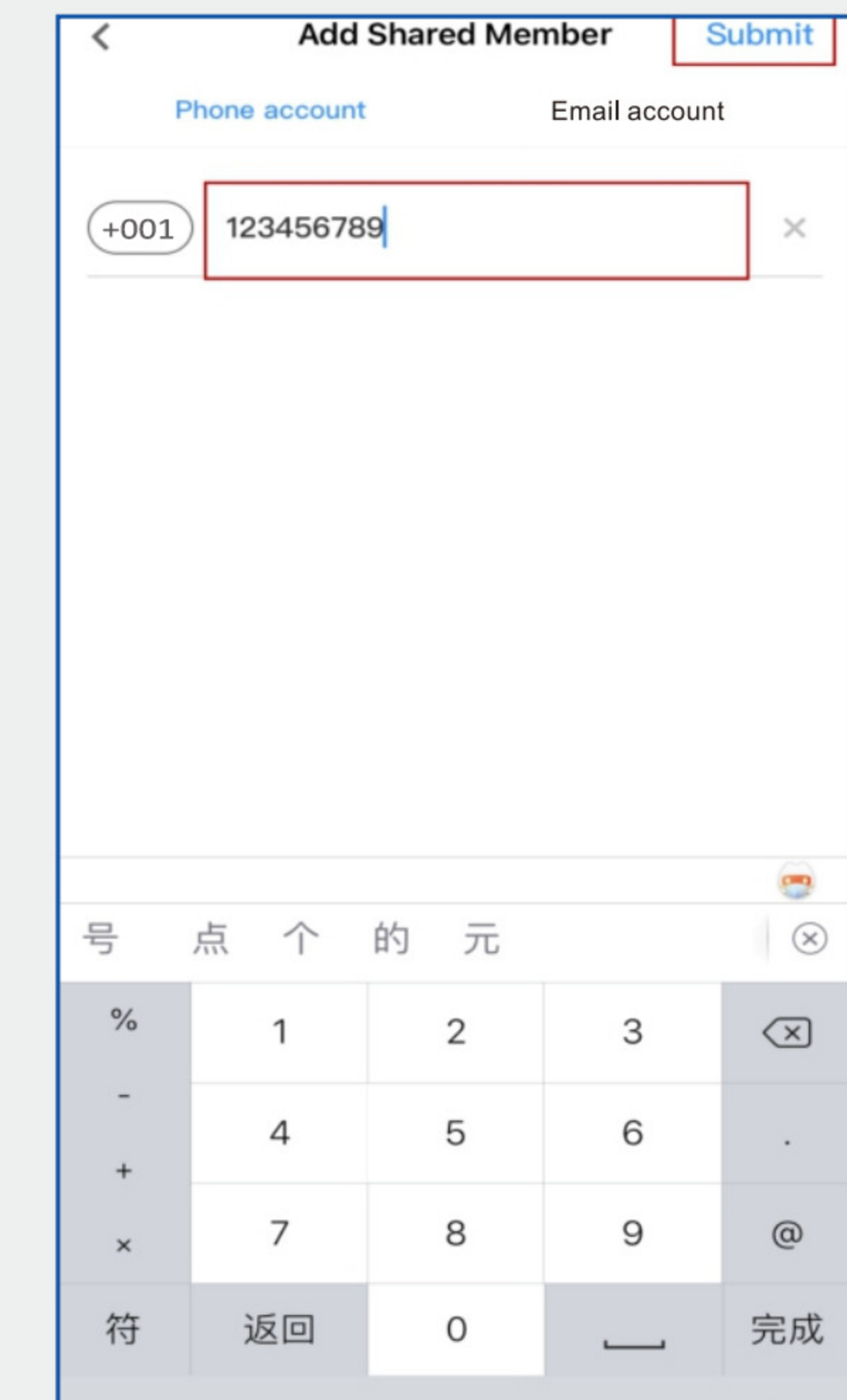
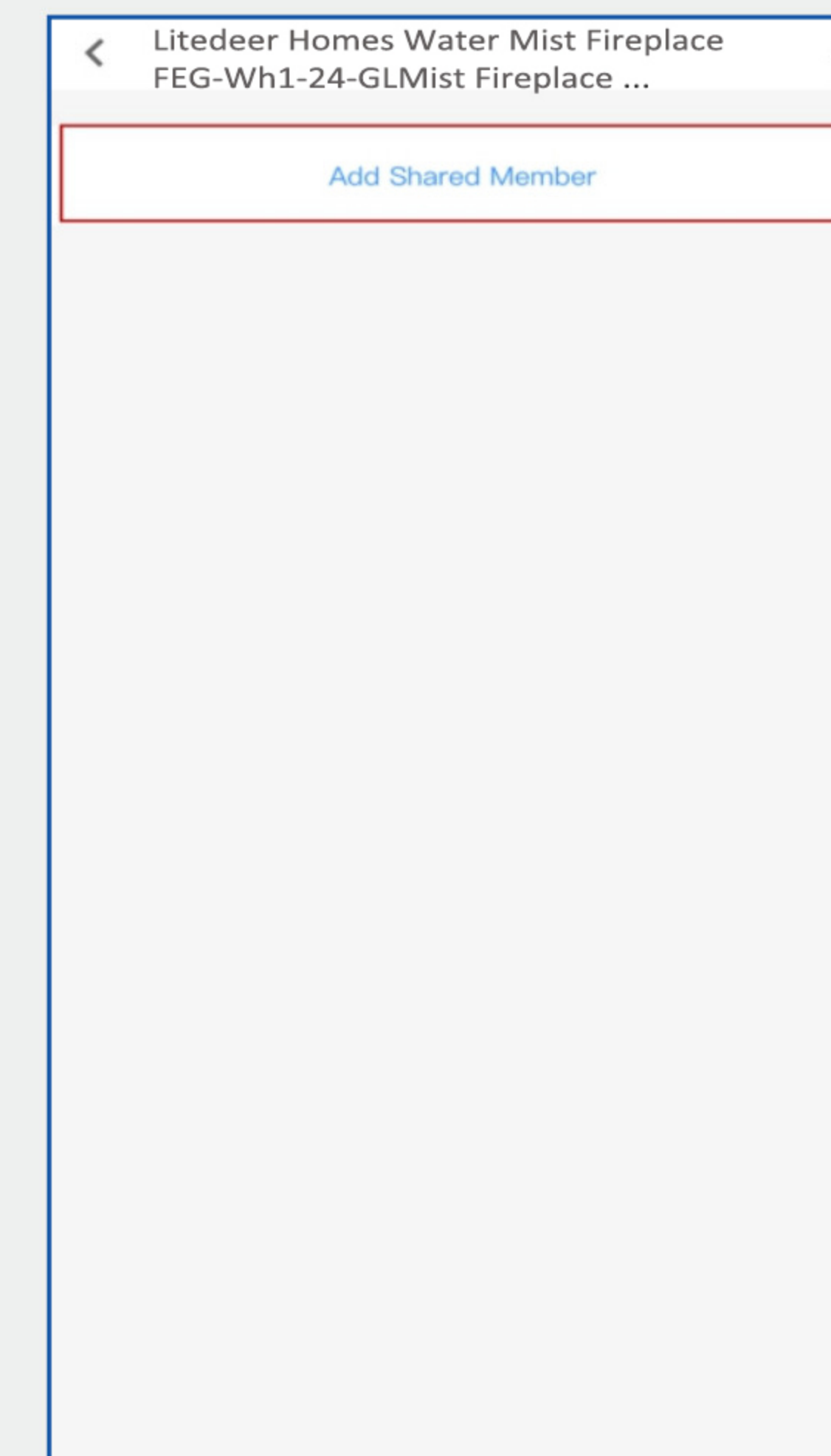
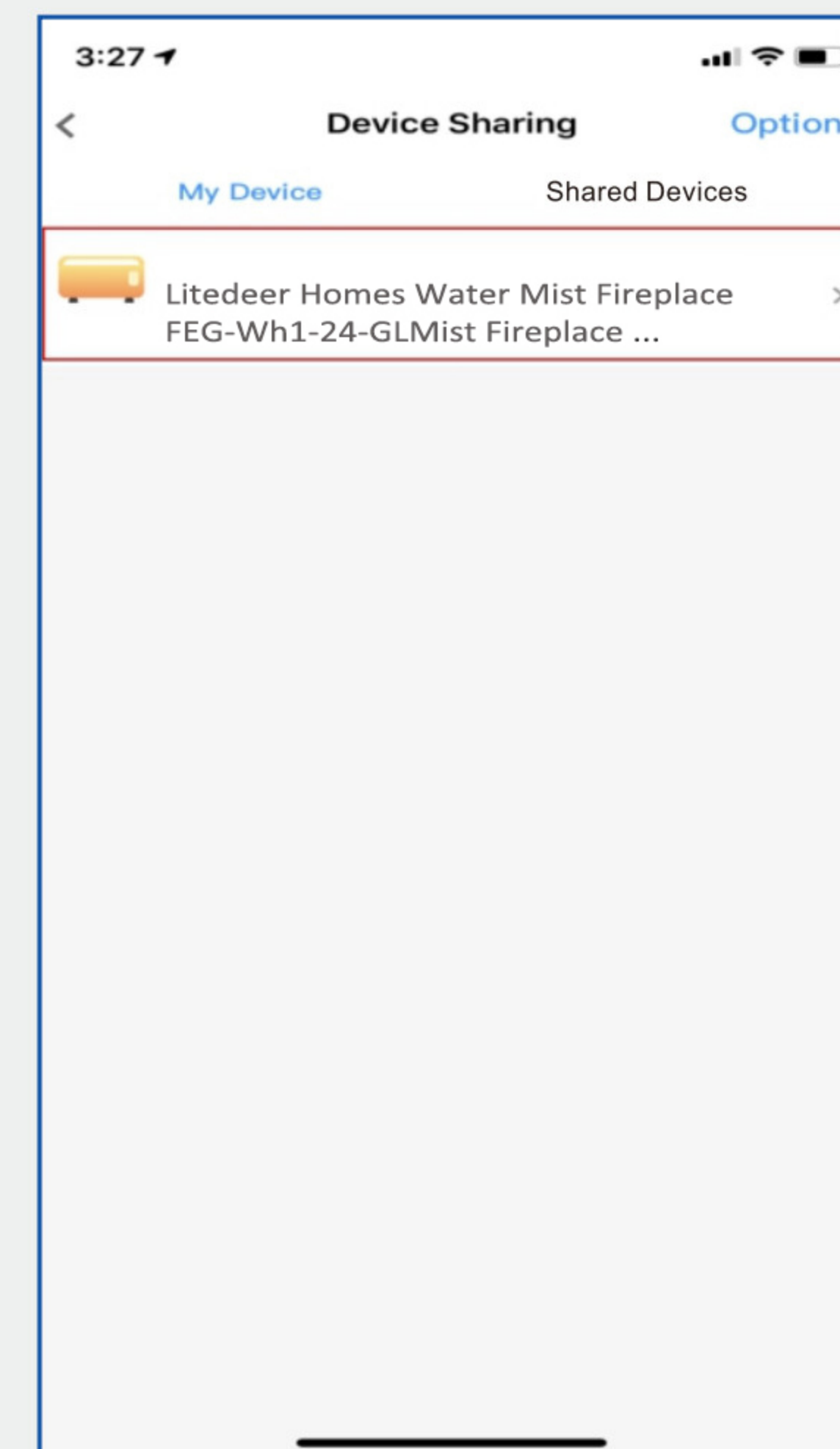
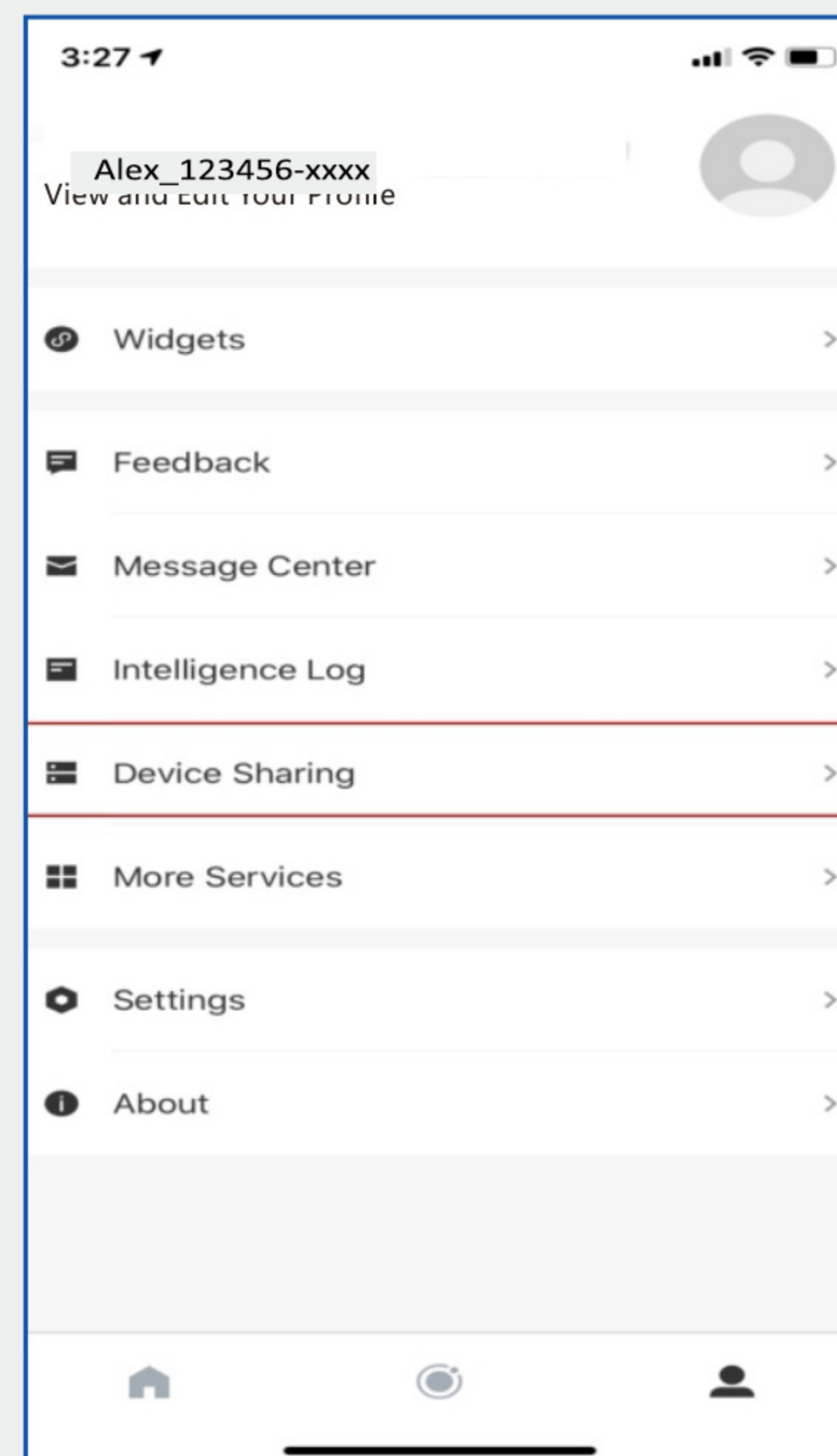
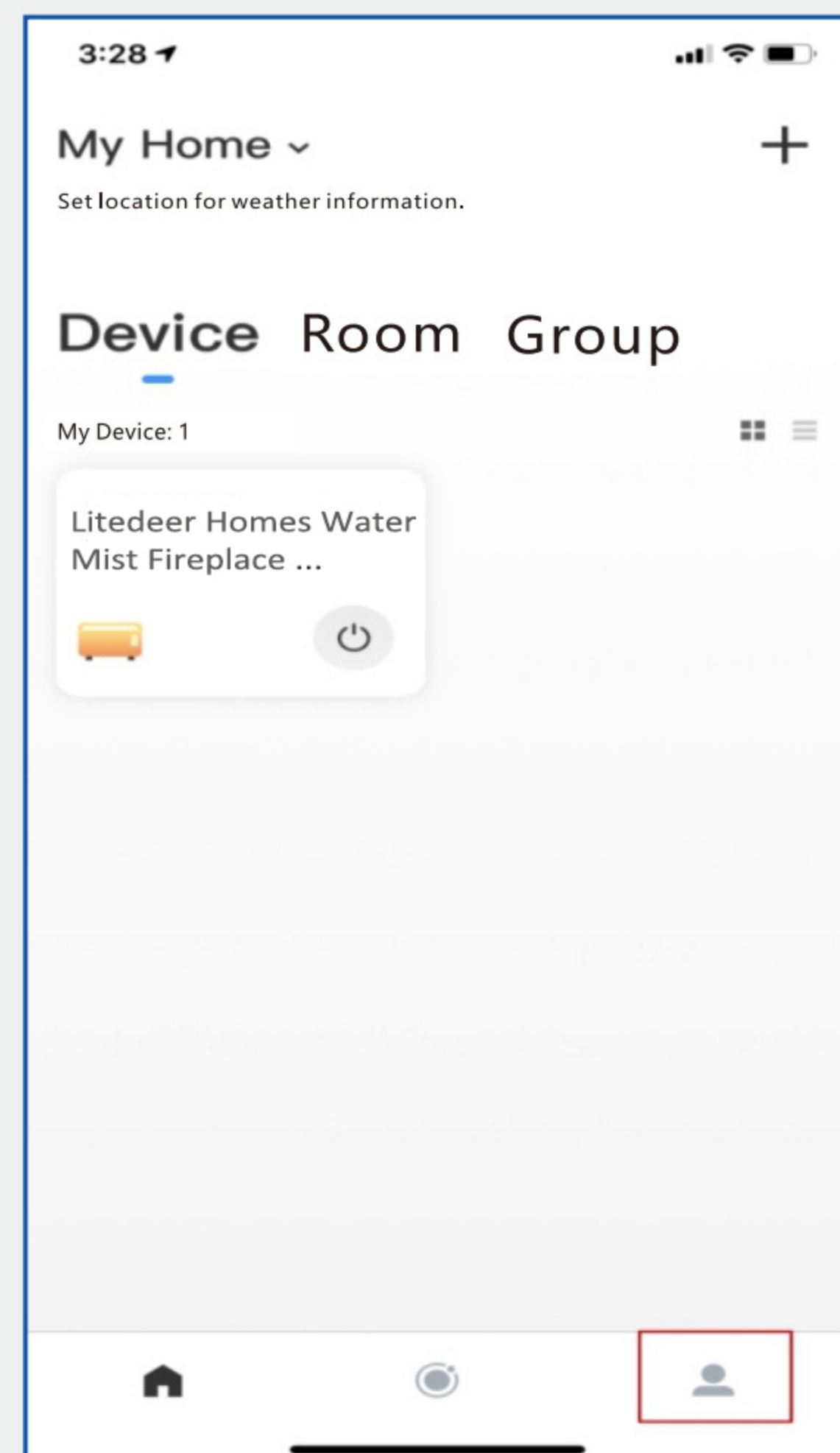



## FAQ

---

### 1 What should you do if the prompt is unsuccessful when adding the device?

Make sure that your device is set to the configuration state as indicated at the beginning;  
Make sure that the WIFI password entered before is correct;  
Make sure the device is not too far away from your home router;  
Whether your router is set to 5GHz network mode, you can enter the router management Settings to check that it is 2.4ghz;  
After the device enters the distribution network state, try to complete the distribution network on the App within 2min. If the time is too long, it is recommended to reset the distribution network state.

### 2 What is the reason for lack of timely response if the device is controlled by APP?

Usually because of network reasons, check the home WIFI router, mobile network status, etc. Since the control service is fed back from the cloud, the operation will still be different from the remote control.

### 3 When do you need to reconfiguration?

Mobile devices to the new network environment (such as the first binding device);  
Reset your router's WIFI password;  
After untying the device on the APP;  
After the device is triggered by mistake and re-enters the distribution network state;

### 4 How do you distinguish between two identical devices ?

It is suggested to click the upper right corner of the device interface, modify the note name, and distinguish the device, after you bind the device.

### 5 Will replacing the phone affect the control and management of the device?

App provides cloud technology services. All the device information associated with your account is properly kept in the cloud. Replacing your phone won't affect it at all.

## Warranty that

Customer warranty card					
Description		Model		Purchase Date	(D) (M) (Y)
USER	Name:		DEALERS	Name:	
	Address:			Address:	
	Telephone:			Telephone:	

Records of the warranty			
The warranty date	Failure and handling methods	Completion date	Customer Signature

### The warranty

- The product shall be repaired free of charge within one year under normal use (the gift does not belong to the warranty scope).
- The starting date of the warranty period shall be subject to the invoice date of the product. please show the invoice when repairing.
- During the warranty period, free maintenance is not granted under any of the following circumstances.
  - a. Failure caused by failure to use according to the instructions.
  - b. Damage caused by self-repair or modification.
  - c. Failure caused by natural disaster, collision or high voltage.
  - d. Failure or damage caused by prolonged use in a hostile environment.
- For products beyond the warranty period, our company's maintenance center will serve you wholeheartedly.